

1

Ceiling- & Wall Absorber | Acoustic Elements

Customised Acoustic Solutions

Products & References



<i>AOS – Editorial</i>	4
<i>Who we are & what we stand for</i>	5
<i>Sustainability - Focus on the product life cycle</i>	8
<i>Products</i>	12
<i>Screen50 Ceiling- & Wall Absorber</i>	14
<i>Screen50 – beat - tris - rhomb -honey Wall Absorber</i>	18
<i>Pebble50 Ceiling- & Wall Absorber</i>	20
<i>Wall Absorber 55/40</i>	22
<i>Wall Absorber 40 with Changeable Cover</i>	26
<i>Broadband-Wall Absorber 90</i>	28
<i>Suspended Screen 55/40</i>	30
<i>3D-Absorber</i>	32
<i>PUR12 Frame</i>	34
<i>Small digression: New sheep's wool</i>	36
<i>PUR12 Acoustic Tiles</i>	38
<i>Cupboard Back Absorber</i>	40
<i>Ceiling Absorber</i>	42
<i>Acoustic Cube & Cylinder</i>	45
<i>Acoustic Pillar & Corner Absorber</i>	47

References	49
<i>Köger Technik GmbH, Gaildorf</i>	51
<i>DZ Bank, Berlin</i>	54
<i>Stellamed, Wittstock</i>	57
<i>KfW Bankengruppe, Berlin</i>	60
<i>Nursery "Bärcheninsel", Stuttgart</i>	63
<i>House R, Eberstadt</i>	66
Fabrics & Materials	69
<i>AOS Fabric Collection</i>	70
<i>Acoustic Filling</i>	71
Contact / Impressum	73

Note: This digital brochure contains direct links to the AOS homepage. Please just follow the signs

More information [...](#) >>

Note: The AOS logo will take you directly back to the table of contents from any page.



More efficiency through better working conditions - that is the goal and at the same time the solution approach for our services and products.

PASSION FOR EXCELLENT ROOM ACOUSTICS AND SOUND INSULATION – AOS stands for excellent room acoustics and sound insulation at the office workplace like no other company in the field of office and object furnishing. More efficiency through better working conditions – that is both the goal and the solution approach for our services and products. Many years of experience, an order-related and high vertical range of manufacture at the company's location in Schopfloch enable us to develop and implement the optimum solution for your project together with you. Thanks to our product solutions and services, open and flexible office structures are accepted and appreciated not only by employers but also by employees.

Who we are & what we stand for



Technisches Datenblatt für Wandabsorber 55, H=800 mm, B=1200 mm, Dicke 55 mm

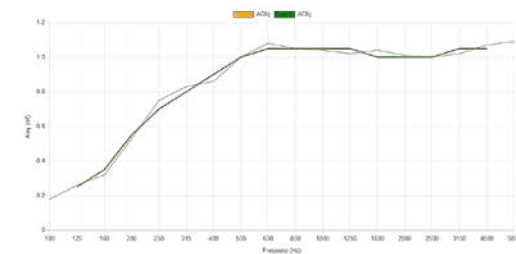

Frequenz f (Hz)	Terzen As (m²)	Oktaven Ap (m²)
50	0.02	
63	0.08	
80	0.11	
100	0.18	
125	0.26	0.25
160	0.32	
200	0.53	
250	0.75	0.70



Absorber
 Bezeichnung Wandabsorber 55, H=800 mm, B=1200 mm, Dicke 55 mm
 Hersteller AOS Akustik Office Systeme GmbH

An order-related and high vertical range of manufacture at the company's location in Schopfloch enables the optimal solution for your project.



High advisory competence & intensive dialogue with customers - A high advisory competence of our employees and the intensive dialogue with our customers offer security for the best room acoustic results. Our services are a guarantee for a healthy and performance-promoting working and living atmosphere and they fulfil the highest design and quality requirements. Our products and services are not only used in office environments, but also in educational and social facilities, in meeting and conference centres and in private homes.

Intensive dialogue provides security for the best room acoustic results.

Flexible production & high vertical range of manufacture - Since the early days, AOS has attached great importance to vertical range of manufacture. The entrepreneurs only purchase raw materials and carry out all work steps on site with their own employees. Production takes place in four halls in Schopfloch, Middle Franconia. Here, the self-developed aluminium profiles are processed and assembled, and the solid wood and wood-based materials are cut to size and processed. In the sewing department, which is strongly affected by growth, the fabric covers are cut, sewn and prepared for final assembly. At the same time, the various acoustic fillings and superstructures are made up in a specially developed process. AOS wants to be able to react flexibly to every customer order and ensure quality on site. "We do not manufacture off the peg." emphasises one of the company founders. "Each element is only cut to size when the order is received. We only store raw materials here in Schopfloch, the further processing is entirely in our hands."



"We do not manufacture off the peg."

Sustainability -

Focus on the product life cycle

DESIGN AND SUSTAINABILITY CREATE ETERNAL VALUES - The AOS claim to design our products sustainably encompasses more than just the selection of the right materials and manufacturing techniques. Decisive for AOS is the entire life cycle of our products, supported by high quality and timeless design. In addition to functionality, performance and costs, the criteria of material separation and recycling as well as repair and maintenance options are becoming increasingly

important in the development process. Because the pressing ecological and social challenges of our time oblige us to act in a committed and consistent manner. Since its foundation in 2005, AOS has been producing high-quality and durable products in sustainable series production on the basis of high-quality craftsmanship and a healthy amount of manual work. The basic structure of our highly sound-absorbing absorbers is completely modular. We use 100% pure materials, which are joined together either positively or mechanically.



The entire life cycle of our products is decisive for us, supported by high quality and timeless design and a timeless design.

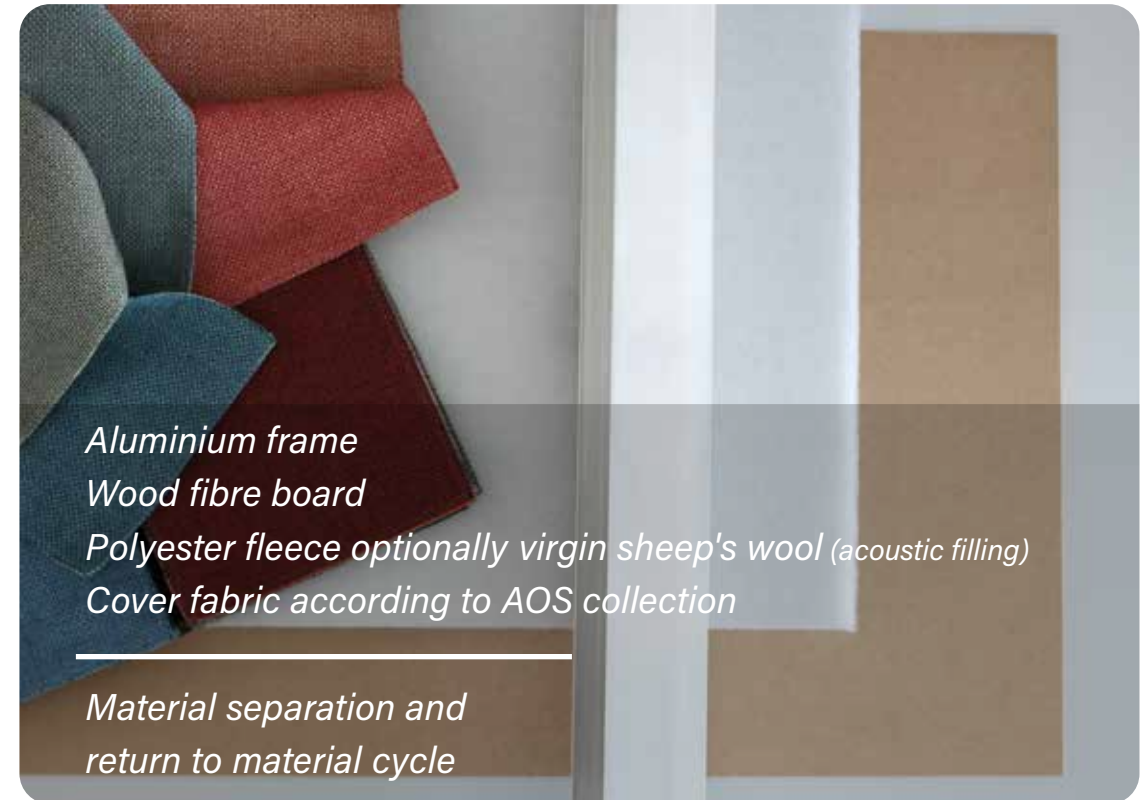

The consistent avoidance of adhesive joints, whenever and wherever possible, guarantees reliable and fast disassembly and material separation in a subsequent recycling process. Ultimately, the decisive factor for the recycling of materials is not only the question of recyclability, but how efficiently the different materials

can be separated from one another and returned to the material cycle. It is also a question of economic efficiency. At AOS, these considerations and principles are firmly anchored in the company and are therefore consistently applied from the initial idea, through product development, to the final design of a new AOS product.

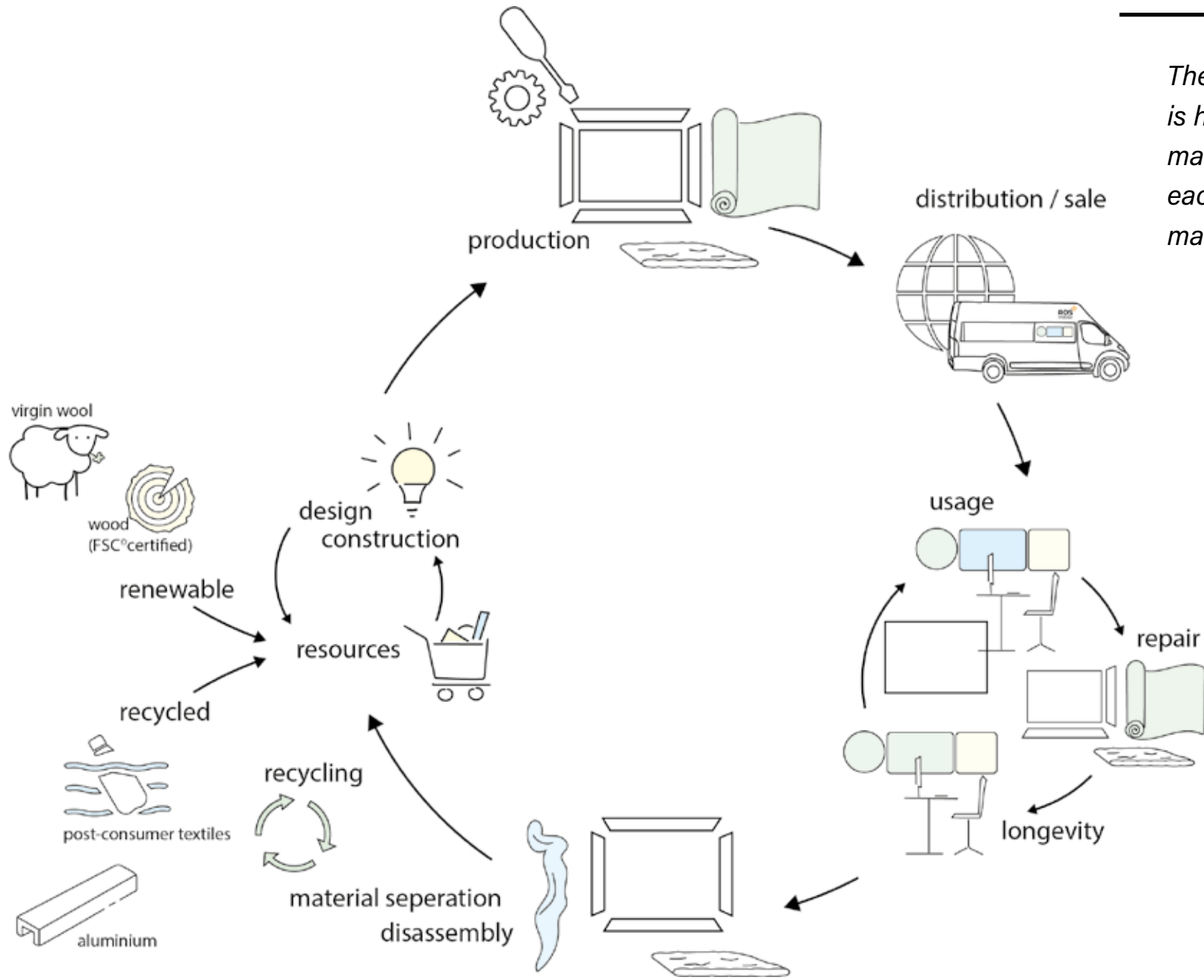

The decisive factor for recycling is how efficiently the different materials can be separated from each other and returned to the material cycle.

SUSTAINABLE CRITERIA DETERMINE THE CHOICE OF MATERIALS – Required technical properties must be fulfilled and match the design of the product in order to minimise its carbon footprint. This includes many criteria such as durability, manufacturing processes, transport routes, material availability, material recycling and, last but not least, safety, which guarantees that the materials we use are harmless to health over the entire period of use.



The virgin sheep's wool used in the AOS Series PUR12 Frame natural, both as an acoustic filling material and as a visible absorber, not only has excellent acoustic properties, but also has the unique ability to filter and sustainably neutralise room air.

*DESIGN DIVERSITY AND
CUSTOMISED ACOUSTIC
SOLUTIONS*

AOS offers design diversity and customised acoustic solutions off the beaten track and uniformed concepts. High-performance products with personality and character, manufactured with a high level of technical expertise and a great deal of attention to detail. A uniquely broad product range and a wide variety of variants offer almost unlimited design possibilities.

Products

Variety of Acoustic Solutions



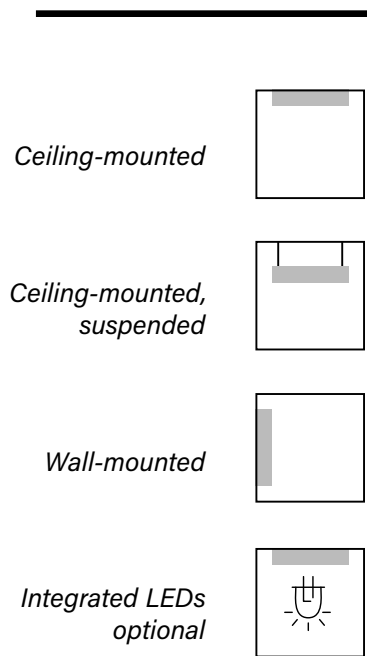

Screen50 Ceiling- & Wall Absorber

*Optionally with LED or
UV offset printing*

The fabric-upholstered ceiling absorbers from the **Screen50 square & round** series (total thickness 50 mm), which are lovingly finished with a quilted seam, not only make an important contribution to acoustic room damping, but are also important elements of interior design. With the absorbers, which are available in 16 different sizes and formats, architects and planners have a versatile product to realise their ideas. **Screen50** elements are not only available for wall or direct ceiling mounting. By means of a stainless steel suspension kit, the round absorbers can be suspended from the ceiling individually and easily adjusted in height. The rectangular formats, based on an 800 mm and a 1,000 mm module, are precisely matched to each other. The mounting distance to each other is designed for 30 mm and so different formats can be combined with each other. The soft and harmonious character of the fabric



upholstery is emphasised by the design language of the rounded corners with a radius of 50 mm. The round formats in 6 sizes from 470 to 1,200 mm offer further creative scope. Available in 17 fabric collections and with over 500 colours, they provide inspiration for creative and at the same time highly sound-absorbent wall design. A suspension fitting with precise height adjustment guarantees quick and safe installation. The ceiling & wall absorbers of the **Screen50** series are also available in other sizes and dimensions on request.



Screen50 Wall Absorber

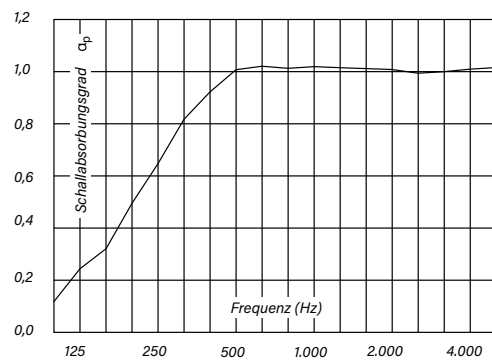

Sound absorption level -
octave centre frequency



Screen50 square & round wall absorber in basic format 800 mm



Screen50 motif wall absorber



Screen50 Ceiling Absorber - direct mounted
20 mm ceiling distance

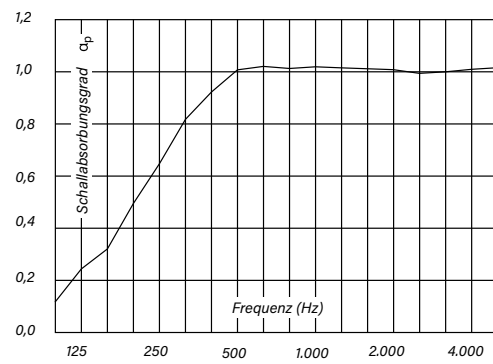

Sound absorption level -
octave centre frequency

Screen50 Ceiling Absorber - suspended
from 400 - 1500 mm ceiling distance

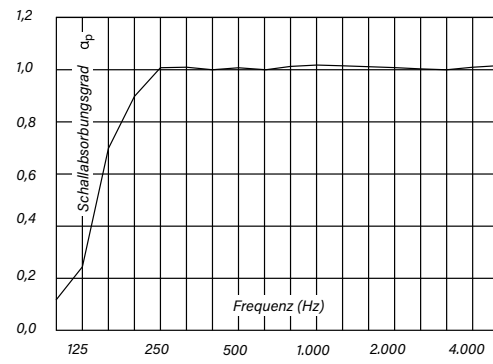

Sound absorption level -
octave centre frequency

*The AOS fabric edge:
Highest quality craftsmanship
with attention to detail*





Screen50 Ceiling Absorber - suspended from 400 - 1500 mm ceiling distance

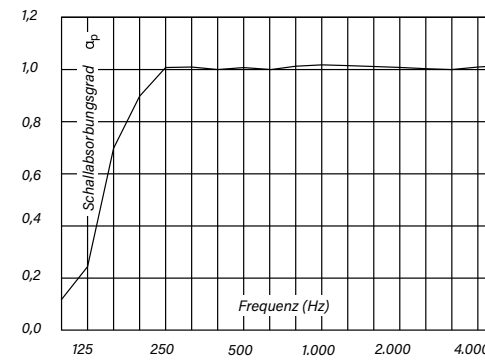

Sound absorption level - octave centre frequency

With appropriate positioning and planning, all lighting requirements for visual tasks for an office workplace according to DIN EN 12464-1 can be met.



[Screen50 Ceiling- & Wall Absorber >>](#)

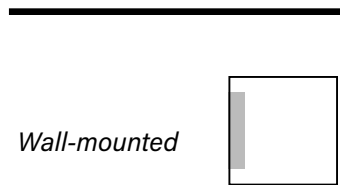

Screen50 - beat - tris -rhomb -honey Wall Absorber

*Design Line freely
combinable*

The fabric-upholstered ceiling absorbers from the **Screen50 square & round** series (total thickness 50 mm), which are lovingly finished with a quilted seam, not only make an important contribution to acoustic room damping, but are also important elements of interior design. The formats and sizes of the **beat, tris, rhomb** and **honey** design lines are coordinated with the previously introduced wall absorbers of the **Screen50 square** family. The 4 design lines presented here offer architects and planners many possibilities and suggestions for realising their ideas. Depending on the design, the formats are based on the basic dimensions of 470, 570, 800, 1000 and 1300 mm. This means that the individual design lines can also be combined with each other. The mounting distance to each other is designed to be 30 mm, so that different formats can be combined with

each other. The soft and harmonious character of the fabric upholstery is emphasised by the design language of the rounded corners with a radius of 50 mm. In contrast, the radii of the **beat** design line are 75 mm. Offered in 17 fabric collections and with over 500 colours, they provide inspiration for creative and at the same time highly sound-absorbent wall design. A suspension fitting with precise height adjustment guarantees quick and safe installation. The wall absorbers of the **Screen50** series are also available in other sizes and dimensions on request.



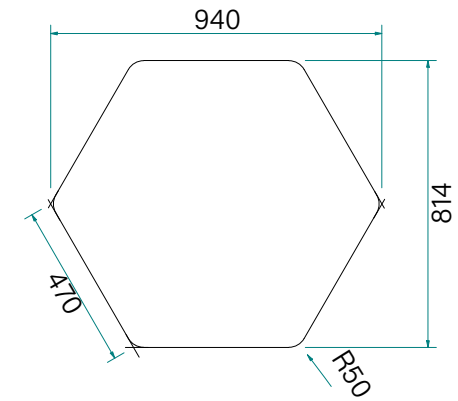
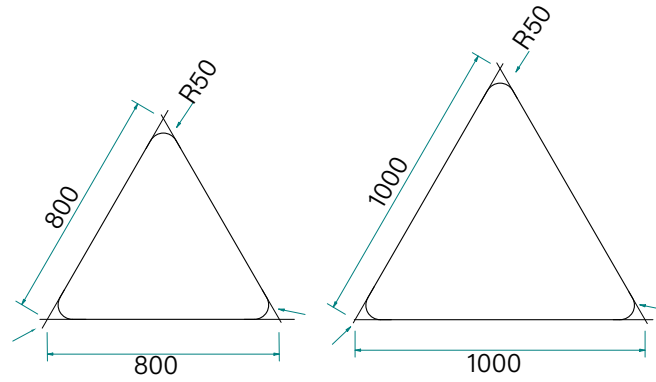
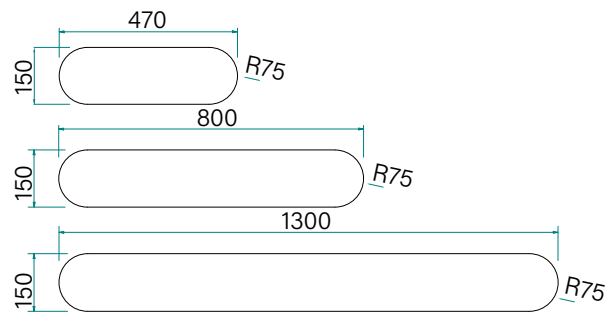

Screen50 Wall Absorber

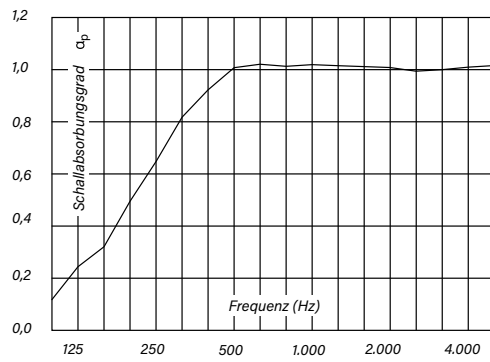

Sound absorption level - octave centre frequency

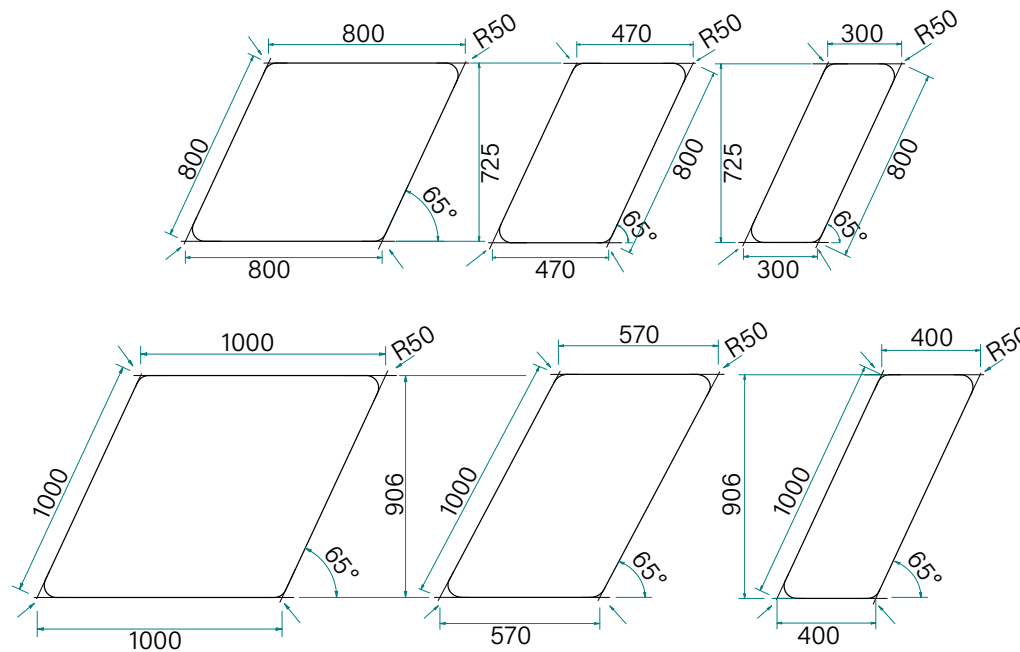

[Screen50 Ceiling- & Wall Absorber >>](#)

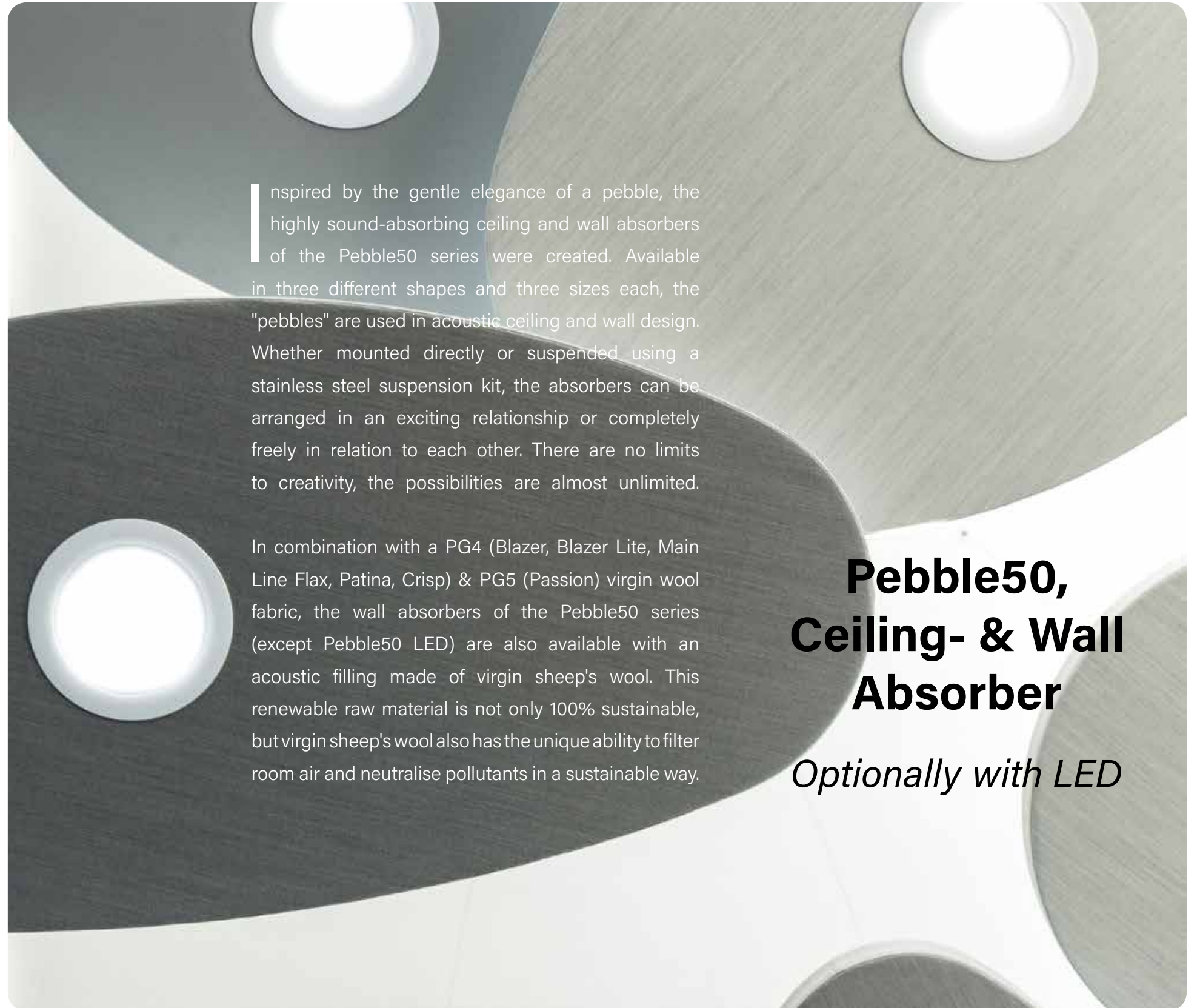
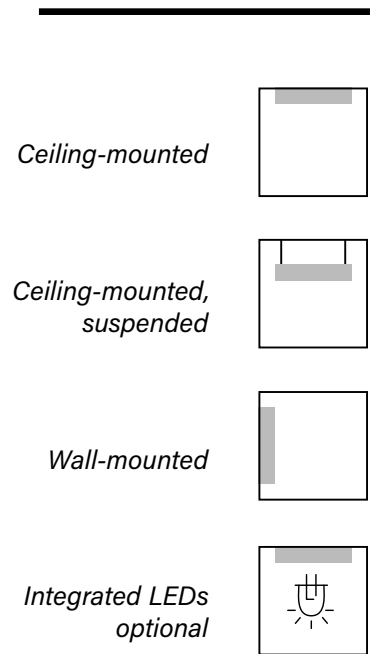

Inspired by the gentle elegance of a pebble, the highly sound-absorbing ceiling and wall absorbers of the Pebble50 series were created. Available in three different shapes and three sizes each, the "pebbles" are used in acoustic ceiling and wall design. Whether mounted directly or suspended using a stainless steel suspension kit, the absorbers can be arranged in an exciting relationship or completely freely in relation to each other. There are no limits to creativity, the possibilities are almost unlimited.

In combination with a PG4 (Blazer, Blazer Lite, Main Line Flax, Patina, Crisp) & PG5 (Passion) virgin wool fabric, the wall absorbers of the Pebble50 series (except Pebble50 LED) are also available with an acoustic filling made of virgin sheep's wool. This renewable raw material is not only 100% sustainable, but virgin sheep's wool also has the unique ability to filter room air and neutralise pollutants in a sustainable way.

Pebble50, Ceiling- & Wall Absorber

Optionally with LED



Pebble50 ceiling absorber with integrated LED recessed luminaire, with LED downlights or wall absorber



With the soft, organic shapes of the "Pebble50" series, a piece of nature moves into our everyday office life.

Pebble50 - direct mounted 20 mm

Pebble50 LED - direct mounted 60 mm

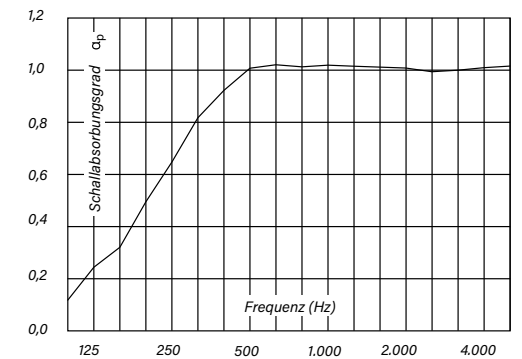

Sound absorption level - octave centre frequency

Pebble50 - suspended from 400 - 1500 mm suspended

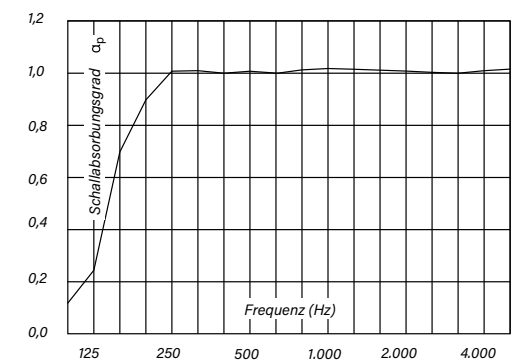

Sound absorption level - octave centre frequency

[Pebble50 Ceiling- & Wall Absorber >>](#)

Wall-mounted

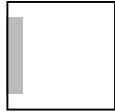

Wall Absorber 55/40

Optionally with digital print

The **55/40 wall absorbers** not only impress with their design quality, but also with their excellent acoustic properties. The high-performance absorbers are available in individual customisation and in four different edge finishes. In addition to the 55 mm wall thickness, the walls are also available in 40 mm. Not only are there several wall thicknesses with different absorption capacities to choose from, but also a variety of fabric qualities and colours. The standard dimensions range from 400 x 400 mm to 1,400 x 2,000 mm. However, thanks to the stable and invisible frame construction made of aluminium, larger formats can also be implemented. A suspension fitting with precise height adjustment guarantees quick and safe installation.

The **wall absorbers 55/40** are available in 17 different fabric collections - divided into 5 price groups. Four different edge finishes also offer design variety: cover profile aluminium anodised EV1, cover profile powder-coated to (RAL), inlying metal profile powder-coated (RAL),



inlying fabric profile according to AOS collection. The elements are offered in standard dimensions as well as in individually requested dimensions.



Wall absorber 40 with inlying fabric profile

Wall Absorber 55/40

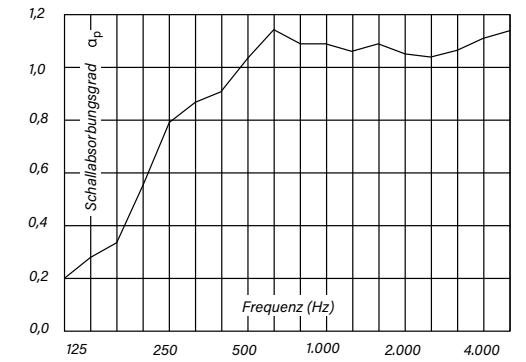

Sound absorption level - octave centre frequency (55 mm)

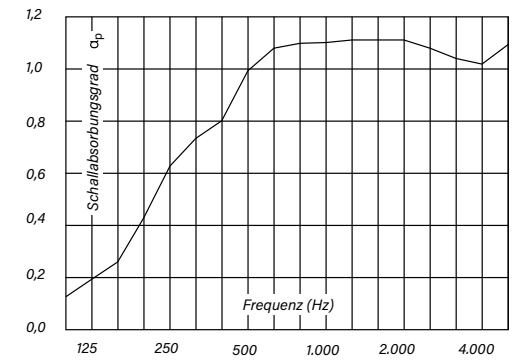

Sound absorption level - octave centre frequency (40 mm)

[Wall Absorber 55/40 >>](#)

*Design diversity
with four
different edge
characteristics.*



*From top left: Wall absorber 55/40 inlying fabric profile according to AOS collection,
cover profile powder-coated to (RAL), inlying metal profile powder-coated (RAL),
cover profile aluminium anodised EV1*



Wall absorber 55/40 with digital print



With the digitally printed absorbers, good room acoustics as well as individual wall and room design can be realised.

Wall Absorber 55/40 with digital print >>

Wall-mounted

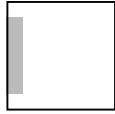

Wall Absorber 40 with Changeable Cover

Lightness and Elegance

The fabric cover, which is stretched over the 40 mm absorber core, is equipped with a circumferential piping and can thus be removed

easily and without tools at any time. The cover can be cleaned easily and professionally and can also be replaced if necessary. **Wall absorbers 40 with changeable covers** are also ideally suited for use with digitally printed fabric surfaces. The profile, which is tapered by 45 degrees to the rear, lends the surfaces lightness and elegance - and this despite the stable aluminium profiles, thanks to which even very large formats can be implemented. The standard dimensions range from 400 x 400 mm up to 1,400 x 2,000 mm and with digital printing up to 2,000 x 2,000 mm. A suspension fitting with precise height adjustment guarantees quick and safe installation.



The **wall absorbers 40 with changeable covers** are available in 17 fabric collections - and also with digital print. Motifs of very different origins can be used, provided the image quality is suitable. Optionally, this wall absorber can also be equipped with a cover that can serve as a projection surface for beamers.



Wall Absorber 40
with Changeable Cover

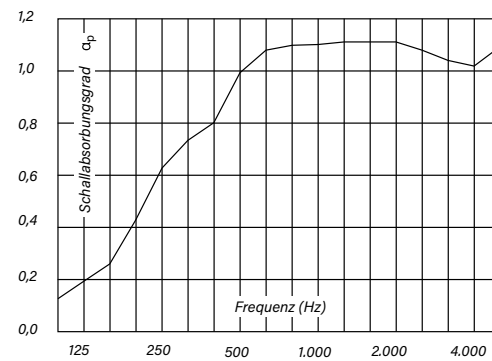

Sound absorption level -
octave centre frequency (40 mm)



Wall absorber 40 with changeable cover, digitally printed

*The elements with
changeable covers are
also ideally suited for use
with digitally printed fabric
surfaces.*

[Wall Absorber 40 with Changeable Cover >>](#)

Wall-mounted

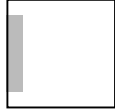

Broadband-Wall Absorber 90

Powerful, straightforward and unobtrusive

Powerful, straightforward and unobtrusive - this could be a brief description of the **AOS Broadband-Wall Absorber 90**. What makes it so valuable is the broad spectrum of its sound absorption values in the entire frequency range of human speech (200 Hz to 2000 Hz). This conductivity is a great advantage, especially in rooms where there is little wall or ceiling space available for acoustic measures. This is particularly important if the room boundary surfaces consist mainly of heavy and reverberant materials such as concrete. In these cases, the **AOS Broadband-Wall Absorber 90** can utilise its full strengths and achieve the desired result with significantly less surface area than is necessary with conventional wall absorbers. This is because a sound absorption performance of ap 0.9 is already achieved in the linguistically very important octave bandwidth of



250 Hz and the maximum possible value of ap 1.0 from 500 Hz. The high-performance broadband absorbers are available in standard sizes with a grid of 200 mm and also in customised sizes. There is a choice of 17 fabric collections in various designs and over 500 colours. The standard dimensions range from 800 x 800 mm to 1200 x 2000 mm. Thanks to the stable and invisible aluminium frame construction in the substructure, the absorbers are extremely dimensionally stable and durable. A suspension fitting with precise height adjustment guarantees quick and easy hanging.



Broadband-Wall-Absorber 90

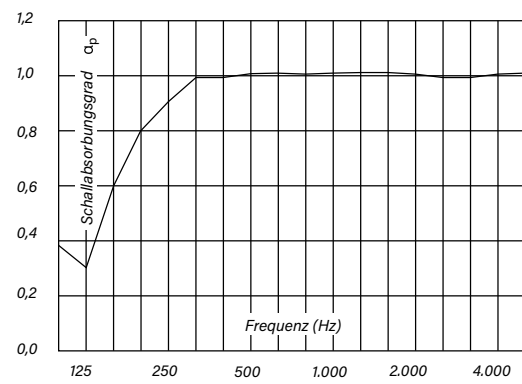

Sound absorption level -
octave centre frequency



[Broadband-Wall Absorber 90 >>](#)

Ceiling-mounted,
suspended

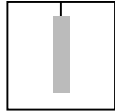

Suspended Screen 55/40

Consistently straightforward and technically timeless

The **suspended screens** impress with their design quality and excellent acoustic properties. The absorbers, which are freely suspended in the room, are available in customised sizes and with four different edge finishes. In addition to the 55 mm wall thickness, the suspended walls are also available in 40 mm. However, there is not only a choice of different wall thicknesses with different absorption capacities, but also a variety of fabric qualities and colours. Thanks to the stable and invisible aluminium frame construction, even large formats can be implemented. Individually **suspended screens** as well as elements positioned one above the other are possible. The stainless steel suspension kit included in the scope of delivery ensures stability and ease of installation.

The **suspended screens** are available in 17 different fabric collections - divided into 5 price groups. Four different edge finishes also offer design diversity: cover profile aluminium anodised EV1, cover profile powder-coated to (RAL), inlying metal profile powder-coated (RAL), inlying fabric profile according to AOS collection.





Suspended screen 55 with inlying profile fabric-covered



Four different edge finishes
and digital printing offer a
wide range of possibilities.

Suspended Screen 55/40

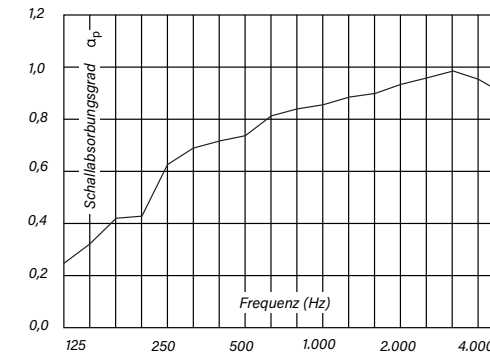

Sound absorption level -
octave centre frequency (55 mm)

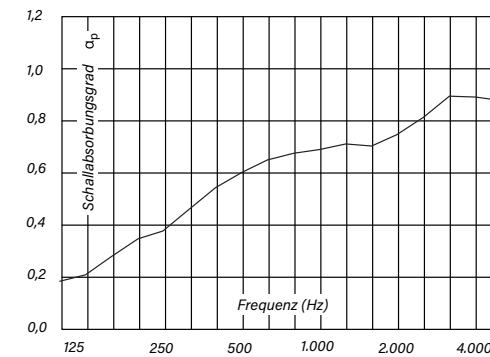

Sound absorption level -
octave centre frequency (40 mm)

[Suspended Screen 55/40 >>](#)

Ceiling-mounted

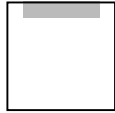
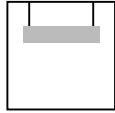
Ceiling-mounted,
suspended

Wall-mounted

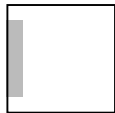

3D-Absorber

Acoustically highly efficient & versatile

Rooms in which communication plays the main role require individual room damping. With the powerful and versatile **3D-Absorbers**, rooms can be designed and furnished with high acoustic efficiency. The absorbers, which are available in sizes of 610 x 610 mm and 610 x 1,220 mm, can be used as wall and ceiling absorbers or as suspended elements. A stable and filigree suspension allows the elements, which are available in different surface finishes and fabric collections, to be used in an airy light or strictly ordered manner to divide the room. For the square **3D-Absorbers**, there is a choice of three different design embossings as well as a version with a sewn-in button.



A wide range of options for individual room design: for a corresponding number of units, planners can also order the **3D-Absorber** with a profile of their own design. The **3D-Absorbers** - which can also be inserted into a grid (625 x 625 mm or 625 x 1,250 mm) - are available in 12 fabric collections, divided into 3 price groups.



3D Ceiling Absorber
610 x 610 mm



3D wall absorber 610 x 610 mm with button or embossing



3D-Absorber suspended

3D-Absorber

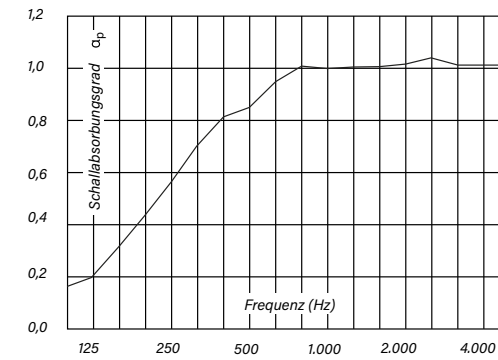

Sound absorption level (suspended) - octave centre frequency

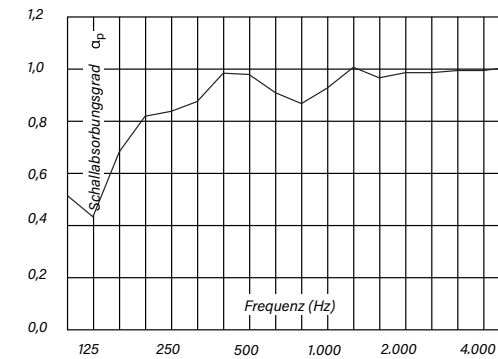

Sound absorption level (ceiling- & wall mounted) - octave centre frequency

[3D-Absorber >>](#)



PUR12 Frame / Frame nature

An expressive acoustic object

Harmoniously clear shapes and high-quality materials touch the senses and move the thoughts. Whether covered with fabric or with a digital print, the wall absorbers framed with an elegant frame are highly sound-absorbent and achieve very good results in the frequency range of human speech. The high-quality absorbers are available in 5 frame versions - lacquered in anthracite, silver or white as well as with a solid wood frame in oak or walnut. In combination with 12 fabric collections **PUR12 Frame** thus becomes a harmonious design element for creating expressive rooms with personality and character. **PUR12 Frame** is available in 5 different formats. As a square with external dimensions of 746 x 746 mm. As a standing rectangle in H746 x W386 mm and H1132 x W746 mm. As a lying rectangle in H386 x W746 mm and H746 x W1132 mm.

Produced with a high level of craftsmanship and attention to detail, **PUR12 Frame nature** ensures well-being and health in more ways than one. The virgin sheep's wool not only has excellent acoustic properties,



but it also has the unique ability to filter and sustainably neutralise room air. Used as an acoustic filling material and as a visible absorber, the extraordinary properties of virgin sheep's wool guarantee pleasant room acoustics and a healthy room climate. The high-quality absorbers of the **PUR12 Frame nature** series are available with 12 different virgin sheep's wool surfaces. The solid wood used for the frame as well as the virgin sheep's wool are a renewable raw material, ecological and recyclable - from nature to nature - and therefore 100 % sustainable.



PUR12 Frame / Frame nature

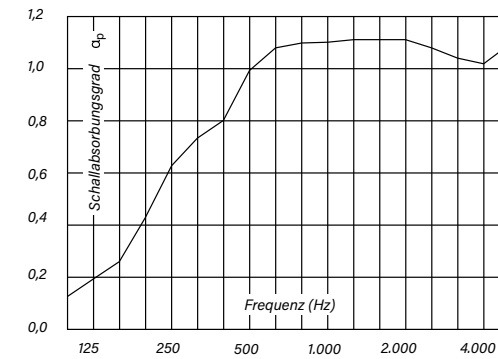

Sound absorption level - octave centre frequency





Virgin sheep's wool has the unique ability to filter and sustainably neutralise indoor air.

Top: PUR12 Frame, with UV offset print, lacquered frame.
Bottom: PUR12 Frame nature with 100 % virgin sheep's wool, frame natural oak

[PUR12 Frame / Frame nature >>](#)

Small digression: New sheep's wool

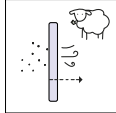
Air purifying & 100 % sustainable

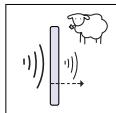
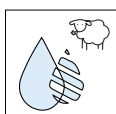
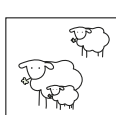
- Air purifying 
- Safety 
- Highly sound-absorbent 
- Moisture regulating 
- Renewable and regional 

AIR PURIFYING FOR A HEALTHY INDOOR CLIMATE: **New sheep's wool** not only has excellent acoustic properties, it also has the unique ability to filter and sustainably neutralise room air. Used as an acoustic filling material in various product series or as a visible absorber in the PUR12 Frame Nature series, the extraordinary properties of **new sheep's wool** guarantee pleasant room acoustics and a healthy room climate. The secret behind the ability to sustainably purify room air is keratin, the protein fibre of which sheep's wool is made. The molecules of the amino acid branches are able to absorb and neutralise pollutants such as formaldehyde.

Scientific evidence: German Wool Research Institute "Absorption and Binding of Indoor Pollutants by Wool using the Example of Formaldehyde, Chemical Absorption of Protein-Reactive Air Pollutants by Wool Diploma Thesis Stefan Thome 2006, Absorption of Air Pollutants by Sheep Wool."

SAFETY AND FIRE PROTECTION: **New sheep's wool** from Upper Austria is used - uniquely reliable also in terms of safety. Due to the consistent use of 100%



new sheep's wool, the special processing technology and the innovative, biocide-free wool protection Ionic Protect, the **new sheep's wool** acoustic filling achieves fire protection classification D according to EN 13501-1.

HIGHLY SOUND-ABSORBENT: The good sound-absorbing properties of **new sheep's wool** are the basis for its use in various AOS acoustic walls and wall absorbers. A multi-layered structure in precisely coordinated dimensions produces the best acoustic results. The products are so versatile that they offer architects and building physicists a great deal of creative freedom.

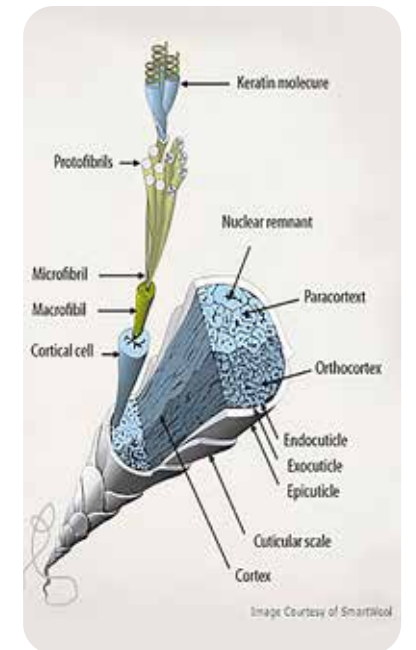



MOISTURE REGULATING: **New sheep's wool** has a hygroscopic effect, which means that it adapts very quickly to the surrounding room air humidity and absorbs moisture if the air humidity is higher than the wool's compensating humidity. If the room air is too dry, it also releases the moisture again.

RENEWABLE AND REGIONAL: **New sheep's wool** comes directly from nature, more precisely: from Alpine sheep from Austria, Germany and Switzerland. It is the only natural filling material for absorbers that is 100% integrated into the natural cycle.

You can use new sheep's wool as a filling material in most AOS products. Please contact us!



Ceiling-mounted

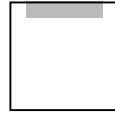

Wall-mounted

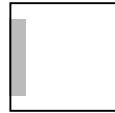

Clear, reduced shapes help to focus on the essentials. High-quality fabrics processed with attention to detail give the **PUR12** series acoustic tiles their unmistakable character. In 10 fabric qualities and with over 300 colours, they are a source of inspiration for a creative and at the same time acoustic wall design. The adhesive tapes applied to the back of the absorbers allow them to be used on almost all common wall surfaces. The acoustic tiles are also excellently suited for double-sided application on glass surfaces positioned freely in the room. The acoustic tiles of the **PUR12** series, which are ideally arranged with a joint pattern of 10 mm to each other, are offered in 5 formats: 170 x 170 mm, 350 x 170 mm, 350 x 350 mm, 710 x 350 mm and 710 x 710 mm. These are precisely coordinated and can be combined with each other.

In combination with 12 different fabric collections and an almost unlimited choice of colours, **PUR12** offers architects and planners an extraordinary variety of design possibilities. The acoustic tiles are also available in other sizes and dimensions on request.

PUR12 Acoustic Tiles

*Acoustics reduced
to the essential*



Clear, reduced shapes help to focus on the essentials.



PUR12 acoustic tiles bonded in wall mounting

PUR12 Acoustic Tiles

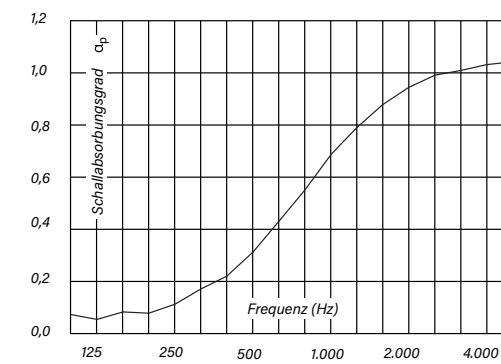

Sound absorption level - octave centre frequency

[PUR12 Acoustic Tiles>>](#)

Cupboard Back Absorber

Simple, straightforward and restrained

Freestanding

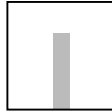

The highly sound-absorbing acoustic **cupboard back absorbers** convince not only with good acoustic properties. Simple, straightforward and unobtrusive, with a total thickness of only 20 mm and a full-surface fabric covering, including the edge profiles, these can be used on almost all carcass types. Depending on the

sideboard or cabinet construction, the fixing method is individually adapted. In addition to screwing through the rear wall of the cabinet, it is also possible to attach it using adhesive, Velcro or magnetic connections. The latter is particularly suitable for cabinets with steel carcasses, provided that the **cupboard back absorbers** can be secured against lowering.



Cupboard Back Absorber

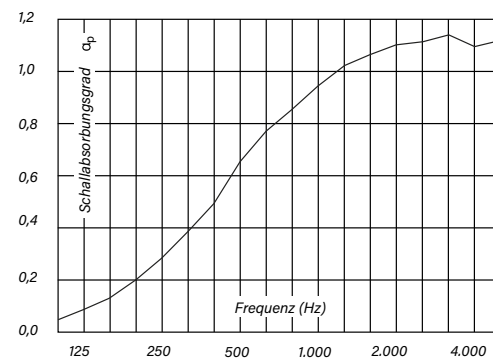

Sound absorption level -
octave centre frequency



[Cupboard Back Absorber >>](#)

Ceiling-mounted

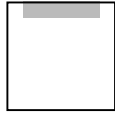
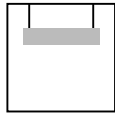
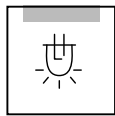
Ceiling-mounted
suspendedIntegrated LEDs
optional

Ceiling Absorber

Optionally with LED

The square and rectangular **ceiling absorbers** combine functional design with a high degree of acoustic quality. Whether mounted directly under the ceiling at a distance of only 20 mm or suspended at different heights using a stainless steel suspension kit, individual options are available for acoustic room planning. The all-round aluminium profile protects the sensitive absorber core and ensures high dimensional stability. Aluminium profiles on the back of the absorbers not only provide stability, but also allow quick and individual adjustment of the suspension points to the ceiling conditions.

The **ceiling absorbers** are available in a wide range of sizes from 1,000 x 1,000 mm to 1,200 x 2,500 mm. In addition to the variant in white fleece, a version in a fabric collection and optionally with powder-coated profiles is also offered. The **ceiling absorbers** are available in standard dimensions as well as in individually requested dimensions.



Room acoustics, light and lighting design merge into an overall architectural solution. Available in square and rectangular shapes, the **ceiling absorbers with LED** downlights combine simple, functional design with a high degree of acoustic and lighting quality. Acousticians can choose from different formats and a flexible suspension height starting at a distance of 100 mm from the bare ceiling. For the lighting designer, different LED downlights offer the technical and aesthetic prerequisites for an excellent lighting design.



From above: Ceiling absorber with individual connection to the supporting profiles of the industrial ceiling, suspended between lighting levels and system ceiling, in direct mounting with a construction clearance

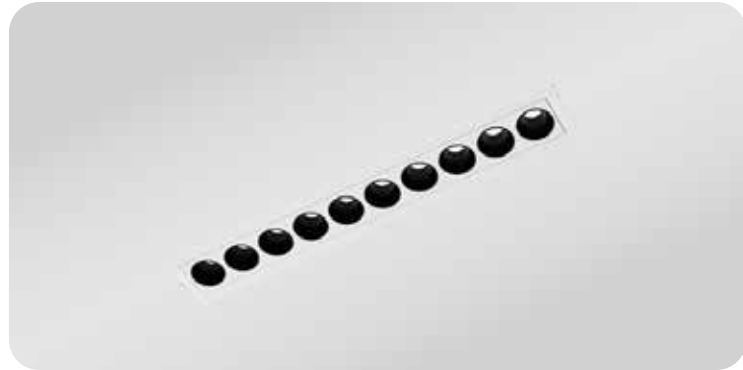

Ceiling absorber with integrated LED downlights

[Ceiling Absorber >>](#)



Ceiling Absorber 40 - suspended
400 - 1500 mm ceiling distance

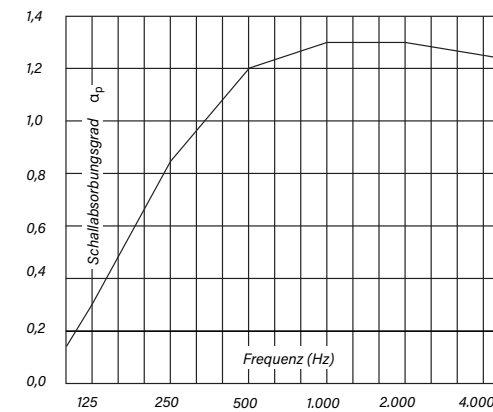

Sound absorption level -
octave centre frequency

Ceiling Absorber 40 - direct mounted 20 mm
Ceiling Absorber 40 LED - direct mounted 60 mm

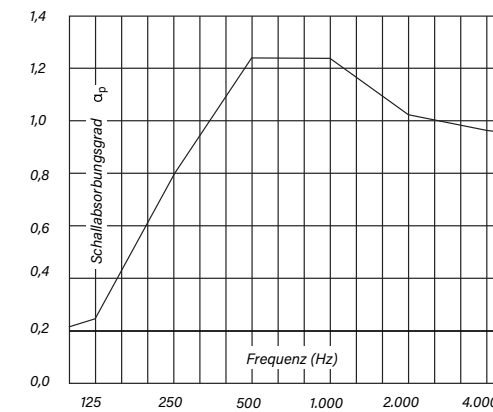

Sound absorption level -
octave centre frequency

Ceiling-mounted
suspended

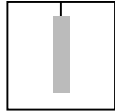

It is often the simple things that make the difference and give the room its individual touch. Freely suspended in the room, seemingly weightless and floating, the highly sound-absorbing **acoustic cubes and cylinders** offer architects and planners the possibility of designing high rooms acoustically and visually. There is a choice of many different fabric qualities - sometimes restrained and simple, sometimes structured and full of character. The fabric cover is removable and can be easily and professionally cleaned and replaced if necessary. The elements are suspended using a stainless steel suspension kit that

is easy to install and can be freely adjusted in height.

The **acoustic cubes** are offered with an edge length of 400 mm and alternatively 300 mm. The **acoustic cylinder** has a diameter of 250 mm and is available in lengths of 800 mm and 500 mm. There are 17 different fabric collections available - divided into 5 price groups.



Acoustic Cube & Cylinder

*Designing high rooms
acoustically*



Top left and bottom: Acoustic cylinder with stainless steel suspension kit
 Top right: Acoustic cube fabric-covered removable

[Acoustic Cube & Cylinder >>](#)

Acoustic Cube & Cylinder

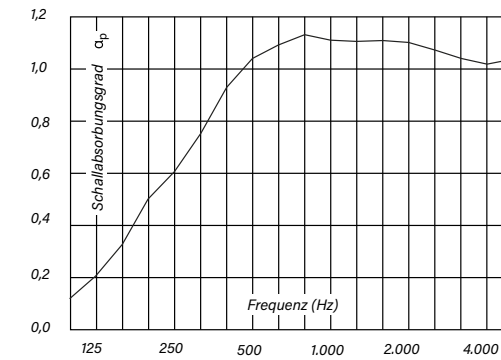

Sound absorption level -
 octave centre frequency (cube)

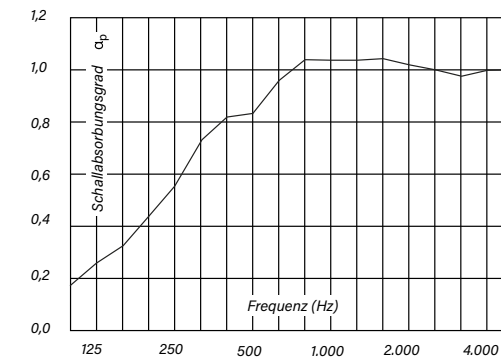

Sound absorption level -
 octave centre frequency (cylinder)

Freestanding

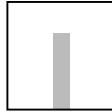

Conference and meeting rooms place high demands on room acoustics, especially speech intelligibility. With the **acoustic pillar and corner absorbers**, which are available in heights of 1,200 mm and 2,000 mm, these rooms can be optimised efficiently and in a space-saving manner. The 400 x 400 mm **acoustic pillar**, which can be used flexibly and independently of walls, have their strengths in the frequency range of human speech and thus produce the best acoustic results. The **corner absorbers** with a face width of 320 mm are equipped with a stand and can thus be adjusted in height by up to 400 mm.

A lot of room for individual design is offered by 11 fabric collections in different qualities and weaves. Removable covers facilitate cleaning and care and thus ensure a long service life.

Acoustic Pillar & Corner Absorber

Efficient and space-saving



Highly sound-absorbing acoustic pillar

[Acoustic Pillar & Corner Absorber >>](#)



Acoustic Pillar

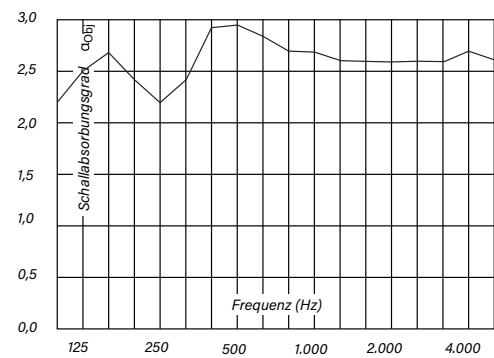

Sound absorption level - octave centre frequency (Acoustic Pillar)

Corner Absorber

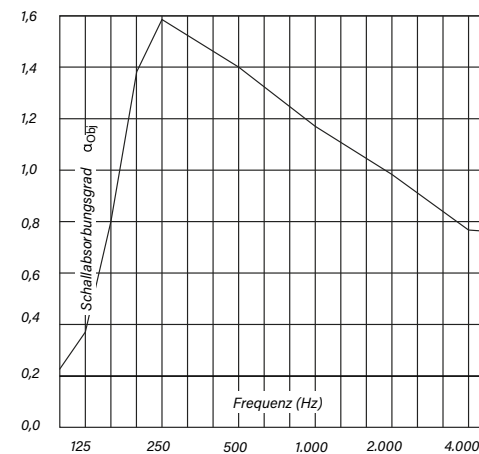

Sound absorption level - octave centre frequency (Corner Absorber)



Acoustic corner absorber

*AOS IS YOUR POWERFUL
PARTNER –*

*in large-scale projects with
individual solutions tailored
to your requirements and
needs. As the specialist for
customized acoustic solutions,
we provide answers to the
growing demand for flexible
and safe forms of work and
working environments.*

References

Impressive acoustic solutions



Köger Technik GmbH

Acoustics & light

Köger Technik GmbH has been active in metalworking since 1986. State-of-the-art technology, maximum precision and close contact with customers and suppliers are the decisive values that already stand for the 2nd generation of Köger Technik GmbH. With a steady growth, investments in a new company building and in modern workplaces followed. The office workplaces are acoustically optimised by the absorbers of the Screen50 series. At the same time, the LED downlight system integrated in the ceiling absorbers ensures the best lighting conditions at the workplace.

The office workplaces are acoustically optimised by the AOS absorbers of the Series Screen50 for ceiling and wall acoustically optimised.



In the spacious reception area with its high ceilings, acoustic wall absorbers from the Screen50 and Kiesel50 series concentrate the background noise. The meeting and team area is located on the first floor, open and flooded with light. Flexible and agile working

is supported by the mobile elements of the AgilityWall Mood series. In addition to various acoustically effective seating cubes, "TouchDown" seating elements from the Silence Point series are also used.



The Screen50 and Pebble50 series dampen the noise that occurs.



Flexible and agile working is supported by the mobile elements of the AOS series AgilityWall Mood.



The Screen50 LED ceiling absorbers round off the room acoustics and lighting design as an overall concept. In this way, Köger Technik GmbH is able to create a wide variety of functional work zones and at the same time contribute to the company's success with a professional appearance in front of customers and suppliers.

*The AOS
Screen50 LED
ceiling absorbers round off the
acoustics and
lighting design
as an overall
concept.*

Reference

Köger Technik GmbH, Gaildorf

Products

*Screen50 >> Pebble50 >> AgilityWall Mood >>
Acoustic Seating >> Silence Point TouchDown >>*

DZ Bank

Acoustic optimisation canteen & lounge

The building at No. 3 Pariser Platz is surrounded by landmarks and is one itself: visitors pass through the main entrance every day to admire the room-filling sculpture in the bright courtyard of this Berlin bank building. Created in 2001, the shimmering silver sculpture that houses the conference area was once described by architect Frank Gehry as "the most ambitious form I have managed in my architectural career". Unlike the famous design for the Guggenheim Museum, for example, Frank O. Gehry had to restrain himself in terms of façade design. This was due to the strict specifications and consideration for the prominent neighbourhood in the heart of Berlin: the Academy of Arts and the US Embassy are directly adjacent to the building to the east and west, and the Hotel Adlon and the Brandenburg Gate are within sight. For the DZ Bank building, Gehry designed a five-storey, strictly symmetrical perforated façade of limestone with recessed frameless window panes. To the south, at

Behrenstrasse 73, a ten-storey apartment building with an undulating façade was also built according to Gehry's plans, separated from the office area by an air space.

The bank's offices are grouped around the atrium, which ends in a spectacular glass roof reminiscent of the flowing forms of a fish. The Skylight atrium resulted from collaboration with the Stuttgart-based structural engineer Jörg Schlaich. The seven-storey atrium provides light for the offices. To make optimal use of daylight, the interior façade clad in pine wood is stepped. The floor of the surrounding gallery is composed of frosted glass elements that allow daylight to penetrate into the offices on the lower floors.

The DZ Bank area also includes a canteen and lounge area. Soon after the opening of the high-quality building, employees and canteen staff complained about the poor

Spectacular architecture turned the DZ Bank headquarters in Berlin into a tourist attraction.

DZ Bank, Berlin

Initially, the canteen and lounge area could not meet the high demands due to difficult acoustic conditions. The acoustic solutions from AOS significantly improve the quality of stay here.





acoustic conditions. The hard surfaces on the walls and ceilings reflected sound and prevented them from holding longer conversations in this area. AOS was commissioned to carry out its own acoustic measurements and to develop an appropriate acoustic concept. Finally, 3D absorbers and wall absorbers were installed in the canteen and lounge in a conversion campaign limited to two days, which did not affect ongoing operations. The cushion-shaped 3D absorbers come into their own on the ceilings. For the walls, digitally printed wall absorbers were chosen: in the canteen, appetiser motifs are shown to advantage, while in the lounge area, reference is made to the award-winning architecture of the building. The result of the acoustic refurbishment satisfied everyone involved. The canteen now also meets the high building standard in terms of acoustics.

Reference

DZ Bank, Berlin

Products

[Wall Absorber 40 with Digital Print >>](#) [3D Absorber >>](#)



The StellaMed senior citizens' residence was built in Wittstock, a town with 15,000 inhabitants in the north-west of Brandenburg. The initiator is Silvia Teschner, managing director of StellaMed GmbH, who was already caring for people in need of care with her company. The impetus for the new building came from surveys and analyses that attested to a great need for assisted living groups in the region. In general, there was a widespread desire among the respondents to live as independently as possible - but with the option of being able to fall back on 24-hour care. "Since there is no such thing here so far, it was obvious to build," says Silvia Teschner. The new building also made it possible to combine the day care and the basic home

nursing station in one place. As for the location, the choice fell on a meadow behind a residential area. The ambulance service, clinic and supermarket are within easy reach. With the completion, wards for day care and home nursing and residential groups for people in need of care were created on about 4,300 square metres. The new residential community for senior citizens forms the heart of the project: a flat building that offers space for two residential groups with eleven residents each on 734 square metres. The kitchen and recreation rooms are located in the slightly rising central section. Rooms for day care and home nursing are located in another building.

Stellamed

Common rooms with acoustic added value



Soon after moving in, the acoustic conditions in the kitchen and dining room turned out to be problematic. The employees complained about particularly noticeable disturbing noises such as clattering dishes, which caused stress and put an additional strain on the already straining daily work routine. AOS carried out acoustic measurements in the two rooms, which are mirror images of each other in the raised central section. These revealed a reverberation time of up to 3 seconds for some frequencies. This was partly due to the ceilings, which were up to 7 metres high, and

partly to the highly sound-reflecting surfaces, such as the hard wall surfaces and the laminate floors laid in the dining areas. With regard to the installation of acoustic elements, the client made various aesthetic specifications: All elements should be placed as high as possible in the room, above an imaginary line that runs beyond the door frames. Together, they decided to install 3D absorbers in the corners of the polygonal room - in an alternation of grey and white elements. The same colour combination was to be used for the acoustic cylinders: The cylinders (dimensions 800 mm

long and 250 mm in diameter) were grouped into three groups of five: Four white cylinders encircle a grey cylinder in their centre. These were suspended from the ceiling above the luminaires. Acoustic cylinders make particular sense for a high air space like the one in Wittstock, as they absorb sound in many directions.

Acoustic improvements were already noticeable during the alterations, which were carried out in one day. And even with the passage of time, everyone involved is satisfied with the result - both aesthetically and acoustically.



Reference

Stellamed, Wittstock

Products

[3D Absorber >>](#) [Acoustic cylinder >>](#)

KfW Bankengruppe

All-round carefree package room acoustics

The headquarters of the KfW Bankengruppe in Berlin are the perfect example of a modern open-space landscape. The client also wanted to achieve optimum conditions in terms of acoustics. Extensive measurements, staff surveys and the integration of acoustic elements helped to achieve this goal.

The new workspaces at the Berlin location of KfW Bank are part of a pilot project based on open room structures. The managers were concerned with improving communication between employees, as well as using the rooms efficiently and designing them to be adaptable. The concept also includes acoustic optimisation: wall

absorbers, on-cabinet elements, behind-desk screens as well as suspended screens and acoustic partitions. The concept of the Stuttgart-based firm Ippolito Fleitz Group, which was commissioned with the design, provides for a mix of communicative areas and zones of retreat. The designers rely on the materiality of fabric-covered surfaces of acoustic elements. Low filing cabinets zone working and connecting zones. Back table screens and partition walls make the workplaces less visible so that quiet working areas are provided within the open space, which are also valuable as places of retreat for the well-being of the employees.

In order to create very good acoustic conditions in this open-space structure, the responsible persons took specific measures: Together with an acoustics office, the planners created a sample room in which all materials and furniture were dimensioned in such

a way that all guideline values and recommendations of the relevant regulations on room acoustics and sound pressure levels in the room were complied with. Subsequently, the acoustic values were determined in three measurements in the occupied sample area.

Behind-desk screens and on-cabinet elements ensure good acoustics and an excellent working atmosphere.



The interior design concept provides for a mix of communicative areas and retreat zones.





The Partitions make the workplaces less visible.

After each measurement, the specialist planners improved the acoustics by optimising measures. In addition, the employees were questioned and thus included in the investigation. Initially, they had complained that speech intelligibility was too high.

Thanks to the very good acoustics, the individual work areas offer an excellent working atmosphere and enable both concentrated and communicative work.

Reference

KfW Bankengruppe, Berlin

Products

Wall Absorber 40 >> Silence Line Partitions, Behind-Desk Elements, On-Cabinet Elements >> Suspended Screens 55/40 >>

Nursery "Bärcheninsel"

*Good room acoustics
& reduction of sound
pressure level*

In a residential area in the Stuttgart district of Dürtlewang - barely visible from the street and hidden by dense tree cover - lies the element-i "Bärcheninsel" nursery. The Stuttgart architects Theo Härtner and Kazu Ito realised a new building for 100 children aged between 1 and 6 years, which replaced the existing building. Anyone entering the two-storey new building through one of the roofed entrances will inevitably find themselves at the "marketplace", the central area of the nursery that links the building's two wings and forms the heart

of the structure. This is where children and nursery staff come together for breakfast and lunch. Adjoining the marketplace are two internal courtyards that open to the outdoors. The building is surrounded by arcades that serve both as emergency balconies and as a covered outdoor play area. Easily visible from the outside are the wooden and steel slats of the arcades, which characterise the façade and act as a soft skin that absorbs overly strong sunlight. From the inside, they provide a barrier to prevent children from falling. Sliding elements are installed in the



Nursery "Bärcheninsel", Stuttgart

The 3D absorbers in the exercise room successfully reduce the noise level.



The combination of wood and exposed concrete as primary materials also characterizes the impressive stairway.

slats. The supporting structure is based on exposed concrete elements poured into place on site. The interior fittings were made of wood, so that the material mix of exposed concrete and wood is both warm and elegant at the same time.

The restrained choice of materials also fosters the educational concept of the private nursery operator, which motivates children and educators to design the rooms themselves. The architecture is intended to fade

into the background and serve as an aid to the interior design. The new building will not have an additional ventilation system except in the sanitary areas and the kitchen. All rooms can be ventilated naturally.

Good room acoustics and a reduction of the sound pressure level in the rooms were achieved with the use of a suspended acoustic ceiling in combination with acoustic elements.

Inviting children to enjoy quiet playtime or relax: Silence Point Concept



At the "marketplace", the Silence Point Concept seating section invites children to enjoy relaxed playtime or serves as a place of retreat; supervisors also use this acoustic solution to relax or chat with one another.

On the upper floor, 3D absorbers reduce the noise level in the exercise room while setting colourful accents on the exposed concrete. Real birch trunks form the central eye-catcher in the so-called "crawlers" rooms on the ground floor. The light-coloured trees convey a sense of protection and comfort and are intended to help the younger children get used to their new environment. The acoustic cylinders hanging from the ceiling harmonise impressively with this unusual ambience and are reminiscent of coloured lanterns swinging in the forest.

The spacious outdoor play area that characterized the complex previously has been preserved – and with it the "island" aspect of the nursery's name which means "teddy bear island". The children who play and learn here are able to enjoy a varied, clear, bright environment that can only help to foster child development.

Reference *Nursery "Bärcheninsel", Stuttgart*

Products

[3D Absorber >>](#) [Acoustic Cylinder >>](#)
[Silence Point Concept >>](#) [Acoustic Seating Elements >>](#)

House R

Exemplary also in terms of acoustics

Eberstadt is nestled between vineyards and forests, 12 kilometres from Heilbronn. In this tranquil town of just over 3,000 inhabitants, a young family has fulfilled their dream of owning their own home. The two-storey house, which was built by the developer K.B.-Wohnbau, opens to the south with wide window fronts that offer a view of the garden and the surrounding area. The relationship to the garden plays a special role for the residents. Since both parents work, the kitchen and dining area take on a special role as social hubs and become the living centre. This zone is kept spacious and designed as an open, bright room continuum. The glass sliding doors allow easy access from here to the spacious terrace, which becomes a "second home" in summer. The lush greenery of the garden areas is also visible at all times from the dining table and centrally positioned kitchen unit, while the view can reach as far as the

tree tops of the opposite slope. To reach the living area, it is enough to climb two steps - it joins the dining area in a northerly direction almost seamlessly.

Soon after moving in, it became apparent that the many smooth, hard surfaces, the open design and the lack of carpets would be to the detriment of the room acoustics. Even conversations between the dining and living areas were sometimes difficult to conduct. Together with the acoustic experts from AOS, it was decided to integrate various acoustic solutions: In the living area, a wall absorber printed with an impressionistic mountain landscape sets visual accents. Two acoustic partitions in matching colours to the interior were used. Elegance

In Eberstadt, Baden-Württemberg, a young family fulfilled their dream of living in the countryside. The house is not only exemplary in terms of energy, but also in terms of acoustics.

*Concept: Setting visual accents,
improved acoustics included*

and dynamism are exuded by the PUR12 acoustic tiles, which are placed in two groups along the staircase in a muted colour combination and harmonise in colour with the floor. Coloured 3D absorbers were also chosen to improve the acoustics on the upper floor.



After work and at weekends, the family enjoys life in the garden and in their modern home, which now also meets the highest acoustic standards.



Reference

House R, Eberstadt

Products

[Wall Absorber 40 with changeable cover >>](#) [3D Absorber >>](#)
[PUR12 Acoustic Tiles >>](#) [Acoustic Partitions >>](#)



A wide range of fabrics is available for **AOS Akustik Office Systeme** products.

Only a limited selection can be shown here.

For further information visit our website

www.akustik-office-systeme.de



Polyester



Recycled Polyester



Trevira CS



Wool

Fabric

Sprint
Era
Medley

Lucia
Rivet
Cura
Xtreme

Lucia CS
Twist/Melange
King L
Roccia

Blazer
Blazer Lite
Connect
Crisp
Main Line Flax
Passion

Material

Polyester

Recycled Polyester

Trevira CS

New sheep's wool 100 %
New sheep's wool 100 %
New sheep's wool 48 %, Recycled Polyester 41 %
New sheep's wool 93 %, Polyamid 7 %
New sheep's wool 70 %, Flax 30 %
New sheep's wool 91 %, Polyamid 9 %

Look

Uni

Melange

Melange

Uni Crepe

Melange

Two-coloured

Uni Crepe

Uni Crepe

Uni/Melange

Uni/Two-/Three-coloured

Two-coloured/Melange

Felt

Felt

Melange

Melange

Melange

Multicoloured

Width

1.500 mm

1.400 mm

1.400 mm

1.700 mm

1.400 mm

1.400 mm

1.400 mm

1.700 mm

1.700 mm

1.400 mm

1.400 mm

1.400 mm

1.700 mm

1.400 mm

1.400 mm

1.400 mm

1.400 mm



Standard: Polyester nonwoven

– 100 % PES fibres

Polyester nonwoven ...

- is recyclable by type.
- consists of approx. 60 % recycled fibres.
- is highly sound-absorbing and reduces reverberation.
- is extremely durable and moisture-resistant.
- is without chemical additives.
- is certified according to Standard 100 by OEKO-TEX®.
- is skin-friendly and allergy-friendly.
- Flame resistance according to DIN 4102: PES nonwoven B1



Optionally: Pure new sheep's wool

– 100 % sustainable

New sheep's wool ...

- is renewable, natural and regional.
- is highly sound absorbent and reduces reverberation.
- is moisture regulating.
- is non-allergenic.
- breaks down pollutants.
- neutralises odours.
- is permanently biocide-free protected by Ionic Protect®.
- has an antibacterial effect.
- Fire protection according to EN 13501: Sheep wool insulation D-s2 d0; Sheep wool felt C-s2 d0;
- is self-cleaning.



www.akustik-office-systeme.de

Impressum

published by
Akustik Office Systeme GmbH
Lenabergweg 5
D-91626 Schopfloch

Editor
Henrik Behnert, AOS

Graphics / Illustration
Sabine Fleischmann, AOS

Photos
Damian Tauchert, Berlin
for AOS

except
page 36 Smartwool, Isolena
page 43 steinprinz fotodesign, Gebr. Becker GmbH, Wuppertal
page 63/64 Simon Sommer, Ostfildern
@2024



Akustik Office Systeme GmbH
Lenabergweg 5
91626 Schopfloch
Germany

Phone +49 9857 97559-0

Fax +49 9857 97559-29

info@akustik-office-systeme.de

www.akustik-office-systeme.de