

Silence Point

5 Acoustic Seating

Customised Acoustic Solutions

Product



Silence Point is a versatile product family with the best acoustic properties, developed and optimised over many years. The modular system is broadly based and ranges from the classic museum bench and various sofa versions to the complete work island with or without a roof. The **Silence Point Lounge** models are not only at home in exclusive lounges, as the name suggests, they have also long since found their way into modern and open office spaces. Whether with or without backrest, the inviting models offer a high level of seating comfort and are equipped to meet the ergonomic requirements of everyday office life and its surroundings. There is a choice of 9 fabric collections with an almost unlimited variety of structures and colours. Among them is the "Passion" fabric with its beautifully textured woollen weave and strongly structured surface. The classic museum bench as a one-seater or two-seater convinces with its clear and restrained design language as a solitaire or charmingly combined with a backrest. Equipped with a soft back cushion, these invite conversation or simply to linger.

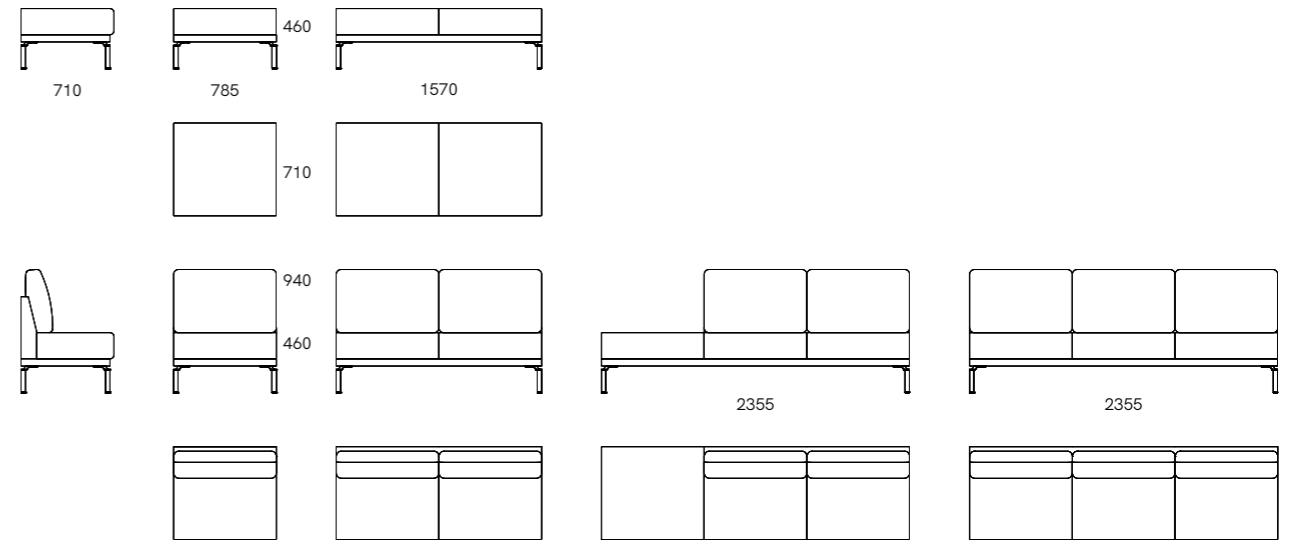

Silence Point Lounge

*Clear shape
with soft character*

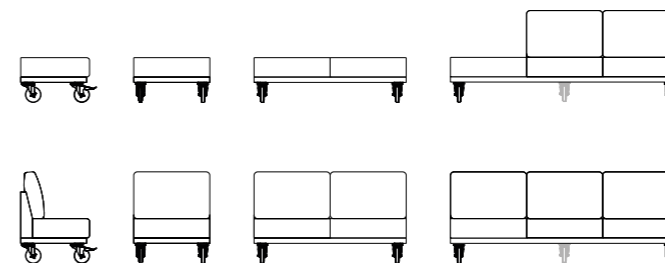

Optionally, all models can be configured to be configured on castors.



Bench (1-Seater)



Bench (2-Seater)



2/3-Seater



1-Seater



2-Seater



3-Seater

*With or without
backrest, the inviting
models have a high
seating comfort.*



Here in combination with acoustic partition walls.



Bench (2-Seater)



Silence Point >>

Silence Point Concept

Wall construction highly sound-absorbing

Straightforward and unfussy in design and with an immensely comfortable seat and backrest upholstery, the **Silence Point Concept** models have the potential to become a "favourite place". Whether on the open office space, in the staircase or in the reception area, the models available in three heights, from 1100 mm to 1400 mm to 1700 mm, create islands of peace and relaxation. What remains hidden from view, the wall construction is highly sound-absorbent at its core and thus ensures excellent comfort. The models are available as one-, two- or three-seaters. There is a choice of 9 fabric collections for the wall construction with an almost unlimited selection of structures and colours. Seating comfort and ergonomic features with invitingly soft back cushions are designed to meet the demands of everyday office life and its surroundings. The walls, which are lovingly upholstered in detail, are also available in the quilted version 114 partial (standard) on one or both sides. For this purpose, 8 fabric collections with different characters are available.

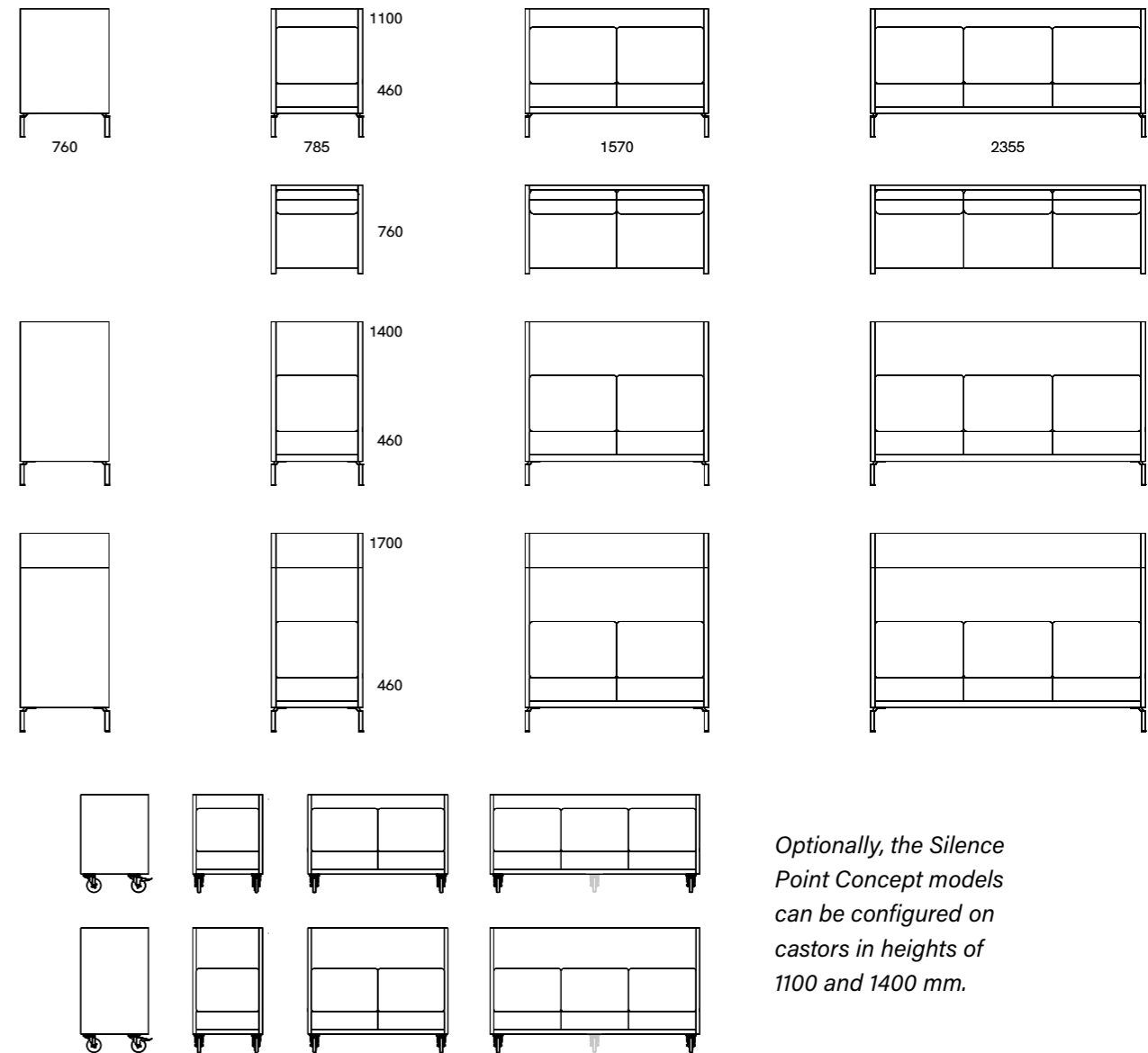

Optionally, the Silence Point Concept models can be configured on castors in heights of 1100 and 1400 mm.



1-Seater



2-Seater



3-Seater

*Model overview:
Three widths &
three heights*



Height 1100



Height 1400



Height 1700



No quilting



Quilted on one side outside

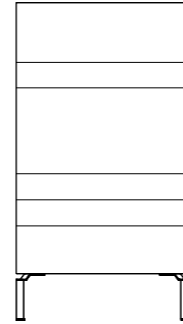

Quilting (standard)
114 partial

Using the example of height 1400 mm



Quilted on both sides

Variety of quilting: In addition to the standard, individual quilting variants are possible on request.

Silence Point 40

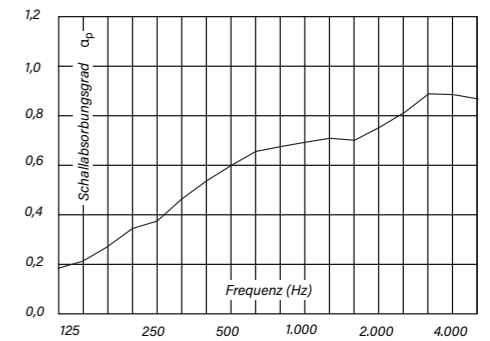

Sound absorption level – octave centre frequency



Whether on the open office space, in the staircase or in the reception area, the Silence Point models create islands of peace and relaxation.



What remains hidden to the eye, the wall structure is highly sound-absorbent at its core.

[Silence Point >>](#)

Silence Point TouchDown

Ergonomics and good acoustics

See, hear, feel: When these three sensory stimuli fit together perfectly, places full of harmony and ideal conditions for creativity are created. The **Silence Point TouchDown** models stand for ergonomics, seating comfort and good acoustics. At the same time, with a width of 1210 mm, they are extremely space-saving. In addition to the choice of 9 fabric collections, further design features ensure design diversity. The walls, which are lovingly upholstered in detail, are available with quilting on one side or optionally on both sides. For this purpose, 8 fabric collections with different character are available. The models are available with or without a desk shelf. Just as contemporary, a configuration on castors is also possible.

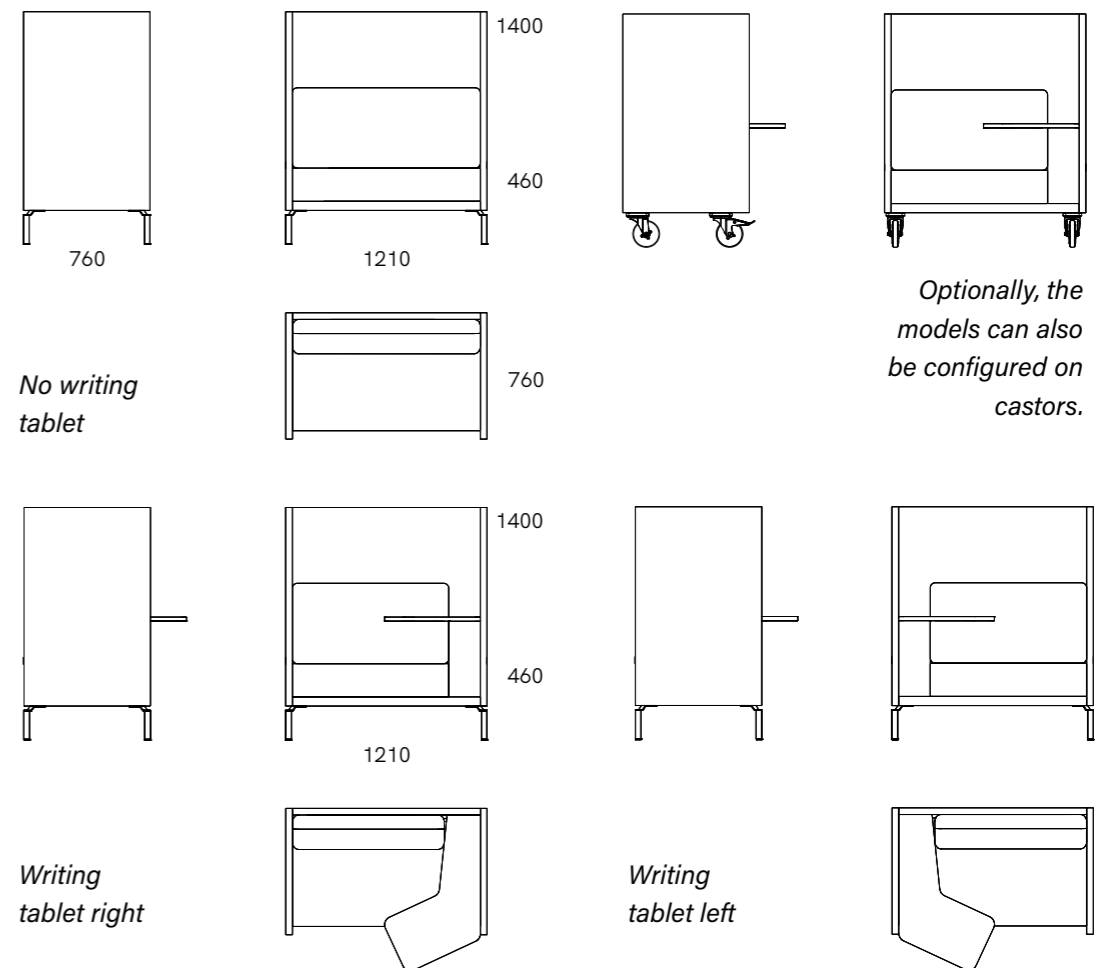

*Quilted
on both
sides*



*Quilted on
one side
outside*



No quilting

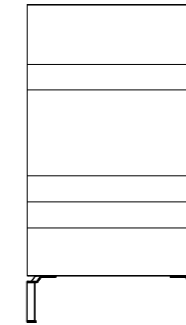

*Quilting
(standard)
114 partial*

*Ergonomic plus: a desk
shelf can be placed on the
right or left.*



*Writing
tablet left*



*No
writing
tablet*



*Writing
tablet right*



Silence Point 40

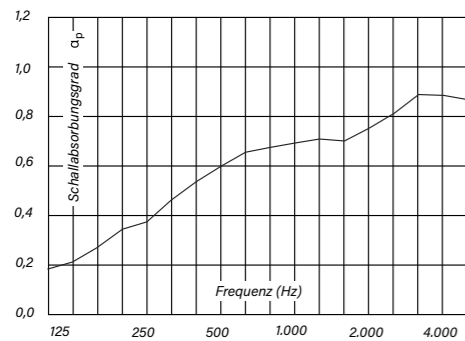

Sound absorption level – octave centre frequency



Contemporary: Agilely configurable on castors.

Silence Point TouchDown models thus stand for significantly more ergonomics, seating comfort and good acoustics.



Silence Point >>

Silence Point WorkBench

Consistently straightforward and technically timeless

Whether it is a work island, meeting point or quiet zone, **Silence Point WorkBench** always presents itself as an eye-catcher with a sovereignty bordering on serenity. The straightforward, classic design language is the result of the reduction to a few decisive functions. For one person, the **Silence Point WorkBench** is a workspace for creative meetings in a small team; for another, it is a place of retreat for concentrated work and quiet conversations. With a footprint of approx. 2200 mm x 1600 mm, they are extremely space-saving and can also be used in the immediate vicinity of lively and restless zones thanks to the best acoustic values in terms of sound absorption and sound shielding. Wall heights from 1400 mm up to 1700 mm, in combination with 9 fabric collections, offer architects and acousticians a great deal of design freedom. The walls, which are lovingly upholstered in detail, are offered in a quilted version on one side or optionally on both sides. For this

purpose, 8 fabric collections with different characters are available. An optional electrification module (PowerDot) integrated into the work table makes the system independent of the office infrastructure.

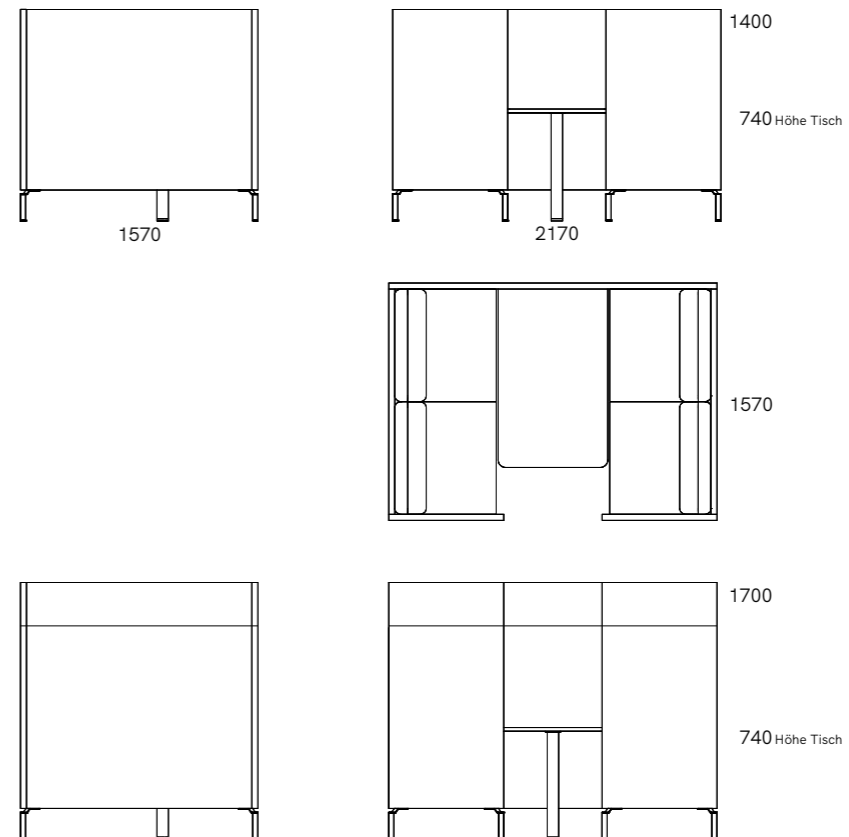



Whether it's a work island, meeting point or quiet zone, Silence Point WorkBench always presents itself as an eye-catcher in the room.

Various versions in height 1400 mm.



No quilting

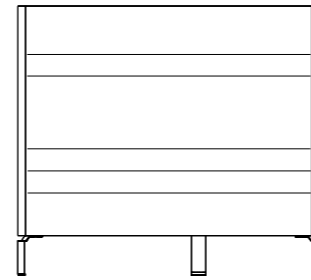

Example
Height 1400 mm

Quilting
(standard)
114 partial

Quilted on one side outside



Quilted on both sides



Example
Height 1700 mm

*Viefalt quilting:
In addition to the
standard, individual
quilting variants are
possible on request.*



Silence Point 40

Due to the best acoustic values in terms of sound absorption and sound shielding, the Silence Point WorkBench can be used in the immediate vicinity of lively and noisy zones.

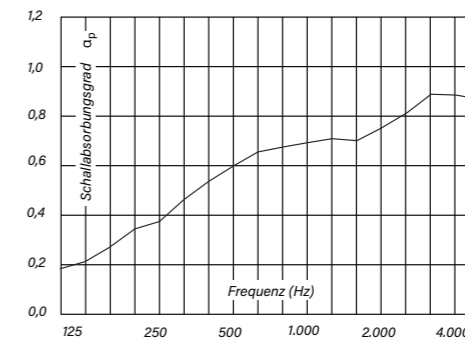

Sound absorption level – octave centre frequency

Silence Point WorkBench height 1400 mm

[Silence Point >>](#)

Silence Point WorkBench Top

*Acoustically highly
efficient & extremely
space-saving*

Like its close relative, the Silence Point WorkBench, the **Silence Point WorkBench Top** with roof is an eye-catcher for any room. All the more so because the beautifully curved roof with integrated LED usually towers far above other furnishings. The straight-lined classic design language is the result of the reduction to the decisive functions. Thus, for one person, the **Silence Point WorkBench Top** becomes a workroom for creative meetings in a small team, for another a place of retreat for concentrated work and for quiet conversations. The vaulted roof over the entire WorkBench ensures that concentrated work or lively discussions are also possible in open spaces with a high ceiling height. With a footprint of approx. 2200 mm x 1600 mm, they are extremely space-saving

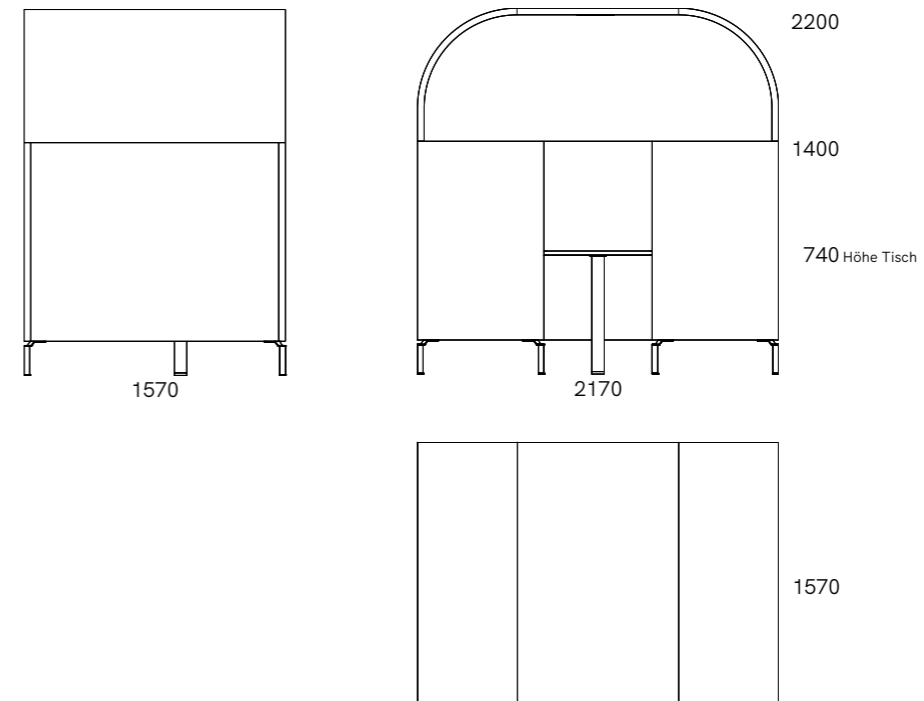

despite the best acoustic values in terms of sound absorption and sound shielding. There is a choice of 9 fabric collections with an almost unlimited selection of structures and colours for the wall construction. The walls, which are lovingly upholstered in detail, are offered in a quilted version on one side or optionally on both sides. For this purpose, 8 fabric collections with different characters are available. An LED light integrated in the standard or an optional electrification module (PowerDot) integrated in the work table make the system independent of the office infrastructure.

No quilting

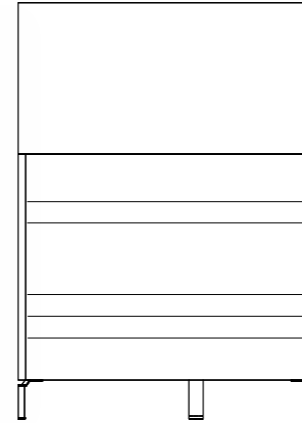

Quilted on one side outside



Quilting (standard) 114 partial

Quilted on both sides



Silence Point 40

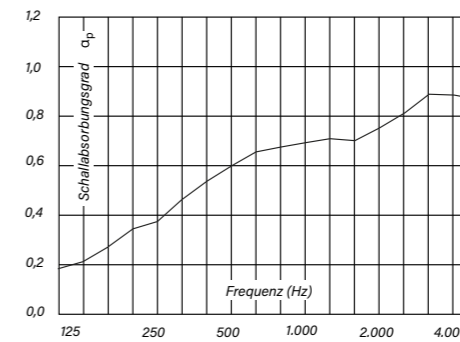

Sound absorption level - octave centre frequency



[Silence Point >>](#)

Silence Point Stream

An expressive acoustic object

A clear design language and excellent seating comfort, **Silence Point Stream** combines function and modern design with an extra portion of cosiness. The inviting models are at home in open office spaces, hotel lounges, stores and showrooms, among other places. Available in two heights of 940 and 1100 mm, the models create comfortable islands to linger and relax. What is hidden from view, the wall structure is highly sound-absorbent at its core and thus contributes to good room acoustics. The models are available as one-, two- or three-seaters. The following are available for the wall construction 9 fabric collections with an almost unlimited choice of textures and colours. This is how the **Silence Point Stream** models become a favourite place with character and an unmistakable appearance. Seating comfort and ergonomic features with invitingly soft back cushions are geared to the

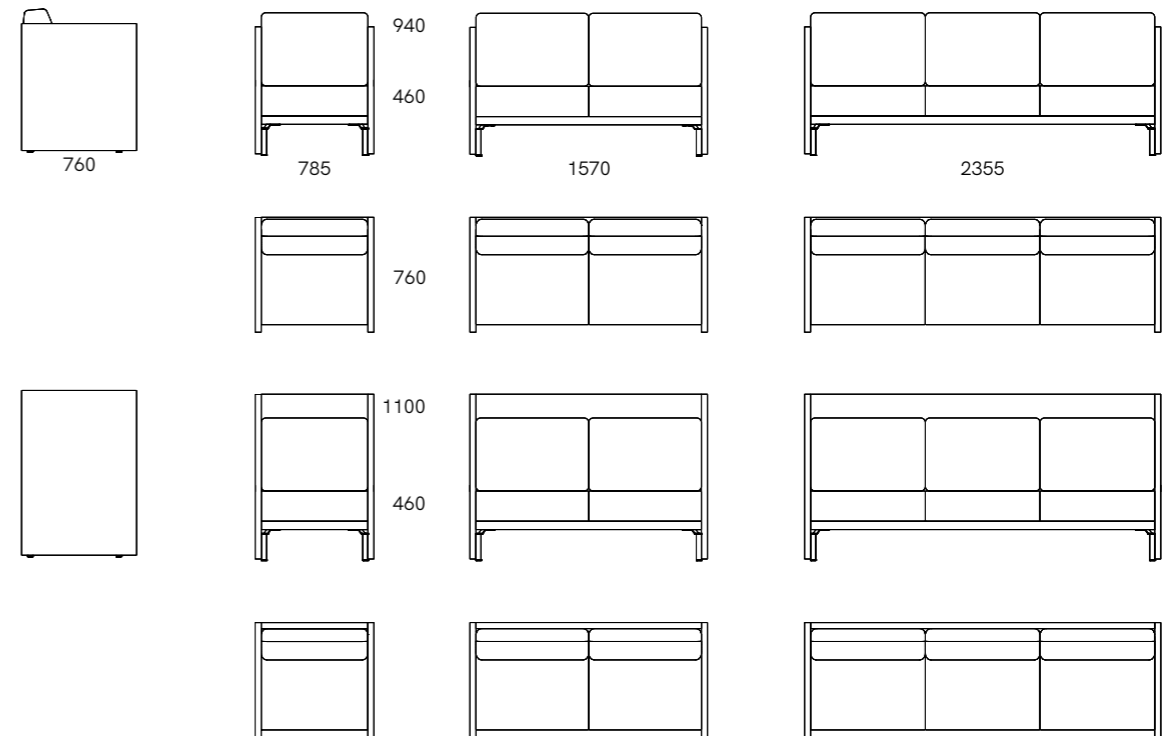

requirements of the project. The walls, which are lovingly upholstered in detail, are offered in a quilted version on one side or optionally on both sides. Here 8 fabric collections with different character are available.



*Model overview:
Three widths &
two heights*



No quilting

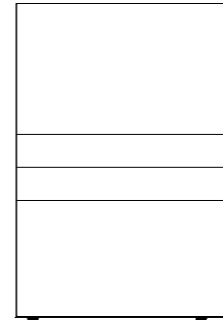

Example height
1100 mm

Quilted on one side outside



Quilting
(Standard)
114 partial

What remains hidden to the eye, the wall structure is highly sound-absorbent at its core and thus contributes to good room acoustics.

Quilted on both sides





Silence Point Stream 3-Seater



Silence Point >>

Impressum

published by
Akustik Office Systeme GmbH
Lenabergweg 5
D-91626 Schopfloch

Editor
Henrik Behnert, AOS

Graphics / Illustration
Sabine Fleischmann, AOS

Photos
Damian Tauchert, Berlin
for AOS

except
Renderings Silence Point Series
page 6, intern
page 14, intern

@2024



Akustik Office Systeme GmbH
Lenabergweg 5
D91626 Schopfloch

Phone+49 9857 97559-0

Fax +49 9857 97559-29

info@akustik-office-systeme.de

www.akustik-office-systeme.de